



CPC-II Current-to-Pressure Converter

Installation and Operation Manual

IMPORTANT



This is the safety alert symbol. It is used to alert you to potential personal injury hazards. Obey all safety messages that follow this symbol to avoid possible injury or death.

DEFINITIONS

- **DANGER**—Indicates a hazardous situation which, if not avoided, will result in death or serious injury.
- **WARNING**—Indicates a hazardous situation which, if not avoided, could result in death or serious injury.
- **CAUTION**—Indicates a hazardous situation which, if not avoided, could result in minor or moderate injury.
- **NOTICE**—Indicates a hazard that could result in property damage only (including damage to the control).
- **IMPORTANT**—Designates an operating tip or maintenance suggestion.

WARNING

The engine, turbine, or other type of prime mover should be equipped with an overspeed shutdown device to protect against runaway or damage to the prime mover with possible personal injury, loss of life, or property damage.

The overspeed shutdown device must be totally independent of the prime mover control system. An overtemperature or overpressure shutdown device may also be needed for safety, as appropriate.



Read this entire manual and all other publications pertaining to the work to be performed before installing, operating, or servicing this equipment. Practice all plant and safety instructions and precautions. Failure to follow instructions can cause personal injury and/or property damage.



This publication may have been revised or updated since this copy was produced. To verify that you have the latest revision, be sure to check the Woodward website:

www.woodward.com/pubs/current.pdf

The revision level is shown at the bottom of the front cover after the publication number. The latest version of most publications is available at:

www.woodward.com/publications

If your publication is not there, please contact your customer service representative to get the latest copy.



Any unauthorized modifications to or use of this equipment outside its specified mechanical, electrical, or other operating limits may cause personal injury and/or property damage, including damage to the equipment. Any such unauthorized modifications: (i) constitute "misuse" and/or "negligence" within the meaning of the product warranty thereby excluding warranty coverage for any resulting damage, and (ii) invalidate product certifications or listings.

NOTICE

To prevent damage to a control system that uses an alternator or battery-charging device, make sure the charging device is turned off before disconnecting the battery from the system.

NOTICE

To prevent damage to electronic components caused by improper handling, read and observe the precautions in Woodward manual 82715, *Guide for Handling and Protection of Electronic Controls, Printed Circuit Boards, and Modules*.

Revisions—Text changes are indicated by a black line alongside the text.

Woodward Governor Company reserves the right to update any portion of this publication at any time. Information provided by Woodward Governor Company is believed to be correct and reliable. However, no responsibility is assumed by Woodward Governor Company unless otherwise expressly undertaken.

© Woodward 2008
All Rights Reserved

Contents

REGULATORY COMPLIANCE	IV
ELECTROSTATIC DISCHARGE AWARENESS	VI
CHAPTER 1. DESCRIPTION.....	1
Introduction.....	1
Construction	2
CHAPTER 2. SPECIFICATIONS	6
Electrical Specifications.....	6
Hydraulic Specifications	6
Performance	7
Environmental.....	8
Physical	8
CHAPTER 3. INSTALLATION.....	11
Receiving Instructions	11
Unpacking Instructions	11
Mounting Instructions	11
Hydraulic Connections.....	12
Electrical Connections.....	13
CHAPTER 4. INSTALLING AND RUNNING THE PC SERVICE TOOL	24
Making the Hardware Connection	24
Locating and Installing the CPC-II Service Tool.....	25
CD Program Installation	25
Obtaining the CPC-II Service Tool from the Internet.....	31
Running the CPC-II Service Tool	32
CHAPTER 5. USING THE PC MONITORING TOOL FOR PERFORMANCE ASSESSMENT AND TUNING	36
Introduction.....	36
Product Overview	36
Performance Trend and Manual Operation.....	38
Redundancy Overview	41
Analog Input Settings	44
Analog and Discrete Output Settings	45
Pressure Demand Linearization Settings.....	46
Detailed Diagnostics.....	47
CHAPTER 6. CONFIGURING THE CPC-II USING THE PC SERVICE TOOL.....	52
Introduction.....	52
Dynamic Performance Settings.....	54
Configure Redundancy.....	56
Analog Input Settings	58
Analog and Discrete Output Settings	60
Pressure Demand Linearization Settings.....	62
Detailed Diagnostics Configuration	63
Calibration	68
CHAPTER 7. REPAIR AND TROUBLESHOOTING	73
General.....	73
Return for Repair Instruction	73
Protective Packaging.....	73
Troubleshooting.....	74

Contents

CHAPTER 8. REPLACING OLDER CPCs AND NON-WOODWARD CONVERTERS WITH THE NEW CPC-II76

CHAPTER 9. SERVICE OPTIONS77

Product Service Options77

Woodward Factory Servicing Options78

Returning Equipment for Repair78

Replacement Parts79

Engineering Services79

How to Contact Woodward80

Technical Assistance80

CHAPTER 10. ASSET MANAGEMENT AND REFURBISHMENT SCHEDULING PERIOD81

CHAPTER 11. LONG-TERM STORAGE REQUIREMENTS81

DECLARATIONS83

Illustrations and Tables

Figure 1-1. Isometric Front View of the CPC-II 1

Figure 1-2. Example System Schematic 2

Figure 1-3. Example Functional Diagram (CPC electronics) 3

Figure 2-1. Pressure Responses 7

Figure 2-2. Maximum Flow Capacity 8

Figure 2-3a. Installation Drawing 9

Figure 2-3b. Installation Drawing 10

Figure 3-1. Example CPC-II Manifold Dimensions 13

Figure 3-2. Wiring Diagram 14

Figure 3-3. Fuse/Breaker Requirements 15

Figure 3-4. Power Supply Input Connections 15

Figure 3-5. Correct and Incorrect Wiring to Power Supply Input 15

Figure 3-6. Recommended Wiring Strain Relief 16

Figure 3-7. Analog Input Connections 17

Figure 3-8. Manual Test Adjustment (shown with cover in place) 18

Figure 3-9. Analog Output Connections 19

Figure 3-10. Discrete Input Connections 20

Figure 3-11. Discrete Output Connections 22

Figure 4-1. Service Port Connections 24

Figure 5-1. PC Service Tool Overview Screen 37

Figure 5-2. Service Tool Header for Redundant Units (showing Master/Slave Status) 37

Figure 5-3. PC Service Tool Performance Trend and Manual Operation Screen 38

Figure 5-4. Redundancy Overview 41

Figure 5-5. PC Service Tool Analog Input Settings 44

Figure 5-6. PC Service Tool Analog/Discrete Output Settings 45

Figure 5-7. PC Service Tool Demand Linearization Settings 46

Figure 5-8. PC Service Tool Detailed Diagnostics Screen 47

Figure 6-1. Accessing the Settings File 52

Figure 6-2. Loading the Settings File to the Device 53

Figure 6-3. Loading the Settings File to the Device 53

Figure 6-4. Dynamic Performance Configuration Page 54

Figure 6-5. Redundancy Configuration Page 56

Figure 6-6. Analog Input Settings Page 58

Figure 6-7. Analog Input Setpoint Scaling 60

Figure 6-8. PC Service Tool Analog/Discrete Output Settings 60

Figure 6-9. PC Service Tool Demand Linearization Configuration 62

Figure 6-10. PC Service Tool Demand Linearization Configuration 63

Figure 6-11. PC Service Tool Diagnostics Settings Editor 63

Figure 6-12. Expected Dynamic Performance 70

Regulatory Compliance

European Compliance for CE Marking

EMC Directive: Declared to 2004/108/EC COUNCIL DIRECTIVE of 15 December 2004 on the approximation of the laws of the Member States relating to electromagnetic compatibility and all applicable amendments.

ATEX – Potentially Explosive Atmospheres Directive: Declared to 94/9/EC COUNCIL DIRECTIVE of 23 March 1994 on the approximation of the laws of the Member States concerning equipment and protective systems intended for use in potentially explosive atmospheres. LCIE 08 ATEX 6123 for Zone 1, Category 2, Group II G, Ex d IIB T3
LCIE 08 ATEX 6124 for Zone 2, Category 3, Group II G, Ex nA IIC T3
or Zone 2, Category 3 G, Ex nA IIC T3
or Zone 2, Category 3 G, Ex nA IIC T4

Other European and International Compliance:

Machinery Directive: Compliant as a component with 98/37/EC COUNCIL DIRECTIVE of 23 July 1998 on the approximation of the laws of the Member States relating to machinery.

Pressure Equipment Directive: Compliant as “SEP” per Article 3.3 to Pressure Equipment Directive 97/23/EC of 29 May 1997 on the approximation of the laws of the Member States concerning pressure equipment.

GOST R: Certified for use in explosive atmospheres within the Russian Federation per GOST R certificate POCC US. ГБ04.Б01140 as 1ExdIIBT3X and 2ExnAIIIT3X

North American Compliance:

CSA: CSA Certified for Class I, Division 1, Groups C and D and Class I, Division 2, Groups A, B, C, & D, T3 at 85 °C Ambient. For use in Canada and the United States. Certificate 160584-1932162

Marine Compliance:

Det Norske Veritas (DNV): Certified for Marine Applications, Temperature Class D, Humidity Class B, Vibration Class B, EMC Class A and Enclosure Class B (IP56) per DNV Rules for Ships, Pt. 4, Ch. 9, Control and Monitoring Systems.

Special Conditions for Safe Use

Wiring must be in accordance with North American Class I, Division 1 or 2, or European Zone 1, Category 2 or Zone 2, Category 3 wiring methods as applicable, and in accordance with the authority having jurisdiction.

Field wiring must be suitable for at least 85 °C and 10 °C above the maximum fluid and ambient temperatures.

The CPC must be used in an ambient temperature range from (–40 to +85) °C.

The maximum oil temperature is 85 °C.

Connect external safety ground terminal to earth ground.

Conduit seals must be installed within 46 cm (18 inches) of the conduit entry when the CPC II is used in Class I, Division 1 hazardous locations.

GOST R Special Conditions for Safe Use

Преобразователь тока в давление типа CPC - II с защитой вида "n" разрешается размещать только во взрывоопасной зоне класса 2, а с маркировкой взрывозащиты вида "d" – только во взрывоопасных зонах класса 1 и 2 согласно ГОСТ Р 51330.9-99.

Запрещается открывать оболочку токоведущего блока при наличии взрывоопасной атмосферы.

Все подключения и отключения должны производиться при условии отсутствия взрывоопасной атмосферы.



Explosion Hazard—Do not connect or disconnect while circuit is live unless area is known to be non-hazardous.

Substitution of components may impair suitability for Class I, Division 1 or 2 or Zone 2 applications.



Risque d'explosion—Ne pas raccorder ni débrancher tant que l'installation est sous tension, sauf en cas l'ambiance est décidément non dangereuse.

La substitution de composants peut rendre ce matériel inacceptable pour les emplacements de Classe I, applications Division 1 ou 2 ou Zone 2.

Electrostatic Discharge Awareness

All electronic equipment is static-sensitive, some components more than others. To protect these components from static damage, you must take special precautions to minimize or eliminate electrostatic discharges.

Follow these precautions when working with or near the control.

1. Before doing maintenance on the electronic control, discharge the static electricity on your body to ground by touching and holding a grounded metal object (pipes, cabinets, equipment, etc.).
2. Avoid the build-up of static electricity on your body by not wearing clothing made of synthetic materials. Wear cotton or cotton-blend materials as much as possible because these do not store static electric charges as much as synthetics.
3. Keep plastic, vinyl, and Styrofoam materials (such as plastic or Styrofoam cups, cup holders, cigarette packages, cellophane wrappers, vinyl books or folders, plastic bottles, and plastic ash trays) away from the control, the modules, and the work area as much as possible.
4. Do not remove the printed circuit board (PCB) from the control cabinet unless absolutely necessary. If you must remove the PCB from the control cabinet, follow these precautions:
 - Do not touch any part of the PCB except the edges.
 - Do not touch the electrical conductors, the connectors, or the components with conductive devices or with your hands.
 - When replacing a PCB, keep the new PCB in the plastic antistatic protective bag it comes in until you are ready to install it. Immediately after removing the old PCB from the control cabinet, place it in the antistatic protective bag.

NOTICE

To prevent damage to electronic components caused by improper handling, read and observe the precautions in Woodward manual 82715, *Guide for Handling and Protection of Electronic Controls, Printed Circuit Boards, and Modules*.

Chapter 1. Description

Introduction

The Woodward CPC-II (Current-to-Pressure Converter, version II) is intended for positioning steam and/or fuel valves and/or associated servo systems. The CPC-II supplies a precise and stable hydraulic control pressure proportional to the (4 to 20) mA input current signal.

In addition to accurate pressure control, the CPC-II is designed for easy mounting and servicing. The manifold mounted housing can be mounted directly to the hydraulic adapter so long as it provides adequate vertical support.



Figure 1-1. Isometric Front View of the CPC-II

The wiring cable enters the CPC-II via a conduit fitting or cable gland. Electrical connections to the printed circuit board are accessible by removal of the top cover. Dynamic adjustments to the device are made using a PC-based service tool.

■ This manual covers all CPC-II models, including the following:

Maximum Supply & Control Pressure Rating	Zone 2, Category 3 Group IIG, Ex nA II T3 Class I, Div. 2 Groups A, B, C, D T3	Zone 1, Category 2 Group II G, Ex d IIB T3 Zone 2, Category 3 Group II G, Ex nA IIC T3 GOST R - 1ExdIIBT3X, 2ExnAIIT3X Class I, Div 1, Groups C and D and Class I, Div. 2 Groups A, B, C, D T3
Supply 25 Bar Control 10 Bar	9907-1106	9907-1103
Supply 25 Bar Control 25 Bar	9907-1102	9907-1100

Construction

The main elements of the CPC-II include:

- Housing
- Rotary 3-way Hydraulic Valve
- Brushless Limited Angle Rotary Actuator
- Electronic PCB Assembly
- Pressure Sensor

Housing

The housing is an anodized aluminum casting, which provides the containment and alignment for the other components. The four bolt internal threaded interface provides the primary mounting support at the fluid interface.

The threaded aluminum cover completes the enclosure. A secondary locking latch is provided to ensure that the cover is correctly assembled to the unit. The enclosure rating is IP56 per IEC EN 60529.

A return spring operates the bottom portion of the hydraulic valve in the lower cavity of the assembly. This return spring moves the hydraulic valve to port the control (output) pressure to tank/drain when the unit is un-powered.

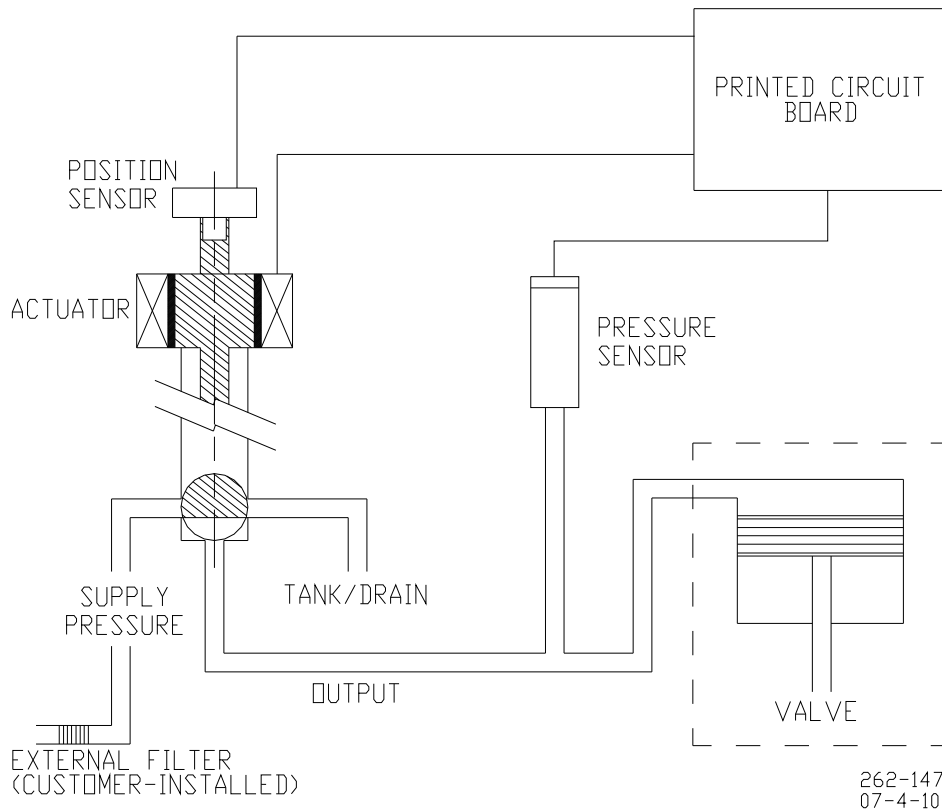

Figure 1-2. Example System Schematic

Rotary Hydraulic Valve

An innovative 3-way rotary valve controls the oil flow from supply to the control (output) port, and from control to drain. (see Figure 1-2). The valve consists of a stainless steel shaft that rotates within a ported stainless steel sleeve. This design offers precise, reliable, and contaminant-tolerant operation on typical oils used for industrial turbine lubrication.

Actuator

The CPC-II uses a rotary limited angle torque (LAT) actuator. The permanent magnet rotor, is directly coupled to the hydraulic valve. The position of the rotor is measured by a solid state integrated circuit on the PCB which detects the direction of the sensing magnet on the shaft. The H-bridge drive is regulated by the microprocessor to control the actuator precisely to maintain the pressure setpoint.

Printed Circuit Board

The printed circuit board is mounted on top of the housing (see Figure 1-3). The printed circuit board performs the following tasks:

- Power Supply
- Isolated Input and Output Circuits
- 2nd input for Redundant Setpoint or Feedback
- PID Control of Pressure
- Model-based Actuator Position Controller
- Actuator H-Bridge Drive
- Current Limiting for Thermal Protection
- Advanced Diagnostics
- Dual Discrete Outputs for Fault and Alarm Enunciation

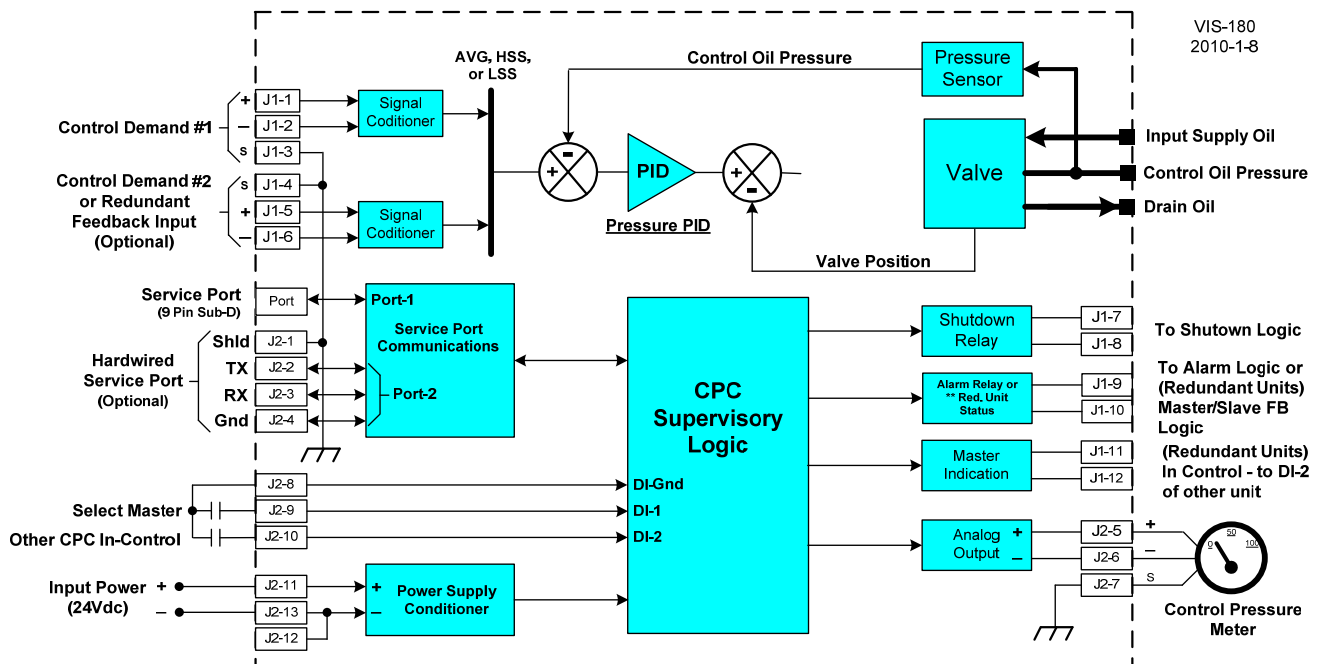

Figure 1-3. Example Functional Diagram (CPC electronics)

The shield connections for Analog Out (J2-7) and RS-232 (J2-1) are through capacitors only as indicated in the wiring section of this manual.

The power supply section performs the EMI filtering on the (18 to 32) V (dc) input voltage and generates controlled voltage for several electronic sub-systems. The power supply system is monitored for proper operation. If the input voltage or internal power systems are detected outside of allowable operating ranges, a diagnostic can be enunciated.

The primary setpoint and redundant setpoint/feedback input signal is designed for a (4 to 20) mA proportional control signal. Each input signal is EMC protected and isolated. Calibration of the setpoint signals to match the servo minimum and maximum travel is performed via the PC service tool. Each input signal is monitored to ensure that the signal is within a valid range. For applications where reliability is critical, the second analog input can be configured as a redundant setpoint input. In the event of an invalid setpoint signal, the CPC can detect this fault and switch over to the 2nd input. Out of range signals can be selected as a shutdown or alarm condition and enunciated on the appropriate discrete output. The shield connections for Analog Out (J2-7) and RS-232 (J2-1) are through capacitors only as indicated in the wiring section of this manual.

The (4 to 20) mA internal pressure transmitter is designed for high reliability, high accuracy, and linearity. The transducer output is monitored by internal diagnostics, which can detect an out of range level and trigger an alarm or shutdown as selected by the user. For applications where reliability is critical, the second analog input can be configured for a separate redundant feedback transducer. In the event of an internal sensor fault, the CPC can detect this fault and switch over to the external transducer (provided by the user). As an alternative, two CPC's can be installed in a fully redundant arrangement, and the 2nd CPC will maintain operation in the event of a signal, transducer, or internal fault of the master unit.

Dual discrete outputs are provided for fault and alarm enunciation. An internal LED also is illuminated when a fault condition is detected. The discrete outputs are configurable for normally-open or normally-closed action.

Closed Loop Pressure Control

The pressure control loop controls the hydraulic valve position to match the feedback signal to the setpoint. The dynamic PID settings can be adjusted to the appropriate dynamic characteristics of the pump and servo system.

The actuator position control loop and pressure control loop are monitored to ensure tracking. If the tracking diagnostics detect a mis-match in either valve position or pressure, a fault condition will be enunciated on the appropriate discrete output.

The position controller regulates a pulse width modulated (PWM) drive signal to the actuator. The drive current to the actuator is regulated, allowing up to 8 Amps to be provided to move the actuator at its maximum speed and torque. A thermal current limit becomes active after a period of a few seconds to protect the actuator and electronics.

The hydraulic valve has three ports: Supply, Control (Output) Pressure and Drain/Tank. With the hydraulic valve in its mid position, the control port is blocked. As the valve rotates clockwise, the supply is connected to the control port, which raises the pressure. As the valve rotates counterclockwise, the control port is connected to drain which lowers the control pressure. The combined action of the pressure and position loop modulate the hydraulic valve position as necessary to match the setpoint.

A unique function of the software is a periodic, symmetrically opposed impulse which flushes silt and debris from the valve system without causing undue wear. At the interval and amplitude selected by the user, this function provides a very rapid motion of the hydraulic valve, in the bypass direction, allowing any silt to be flushed to the drain passage. This motion is followed immediately by a step in the increase direction of the same amplitude to restore the slight fluid volume lost during the downward step. The opposing symmetry of the impulse results in no net change in fluid volume to the controlled servo, and thus does not interrupt the control of the turbine. This unique function provides a higher degree of stability, reliability, and silt resistance as compared to other converters on the market.

If the unit detects any diagnostic shutdown condition, or if the detected diagnostic condition prevents reliable control, or if a loss of power occurs, the return spring forces the valve to connect the control pressure to drain.

Chapter 2. Specifications

Electrical Specifications

Connections	Removable terminal suitable for (0.8 to 3) mm ² / (12 to 18) AWG stranded wire
Cable Entries	Entry via two ¾"-14 NPT threaded ports suitable for North American conduit or ATEX certified Cable Gland Fittings
Supply Voltage	(18 to 32) V (dc), 24 V (dc) nominal (use cable at least 3 mm ² / 18 AWG)
Power Consumption	25 W steady state Transient 90 W (2 s maximum)
Setpoint Signal	(4 to 20) mA into 200 Ω. 70 dB CMRR. Common Mode Voltage Range: ±100 V
Redundant Input or Feedback Signal	(4 to 20) mA into 200 Ω. 70 dB CMRR. Common Mode Voltage Range: ±100 V
Analog Output Signal	(4 to 20) mA. Maximum external load: 500 Ω Accuracy ±0.5 % of full scale
Discrete Output Signal	Configurable for NO or NC, 0.5 A at 24 V (dc), max. 32 V (dc) 0.5 A inductive at 28 V (dc) 0.2 Henry
Silt Buster Frequency	2.4 seconds to 30 days; default setting is 1 day
Amplitude	Zero is minimum and default 0.5 % Maximum valve position. (Impulse is symmetrical, that is, ± the selected value)
Duration	Zero to 100 ms

Hydraulic Specifications

Connections	Flat mounting face with 3 holes. See Figure 2-3a for hydraulic connections, and Figure 3-1 for mounting via an adapter plate (optional).
-------------	--

Supply and Control
Pressure Ratings

CPC-II Model	Input Supply Pressure	Control Pressure Range*
10 bar 9907-1103 9907-1106	25 bar / 363 psi	(0 to 10) bar / (0 to 145) psi
25 bar 9907-1100 9907-1102 9907-1191	25 bar / 363 psi	(0 to 25) bar / (0 to 363) psi

IMPORTANT

* The recommended maximum control pressure is less than 70 % of the supply for the best dynamic performance. Pressure stability of supply must be within ±2 % of the minimum control pressure.

Tank Pressure 2 bar maximum or 30 % of the minimum control pressure whichever is lower

Internal Leakage (Supply to Drain) 2 L/min max at 25 bar inlet pressure
 Depends on pressure differential between supply and control ports. See Figure 2-2.
 Flow Capacity

Recommended Fluid Mineral or synthetic based oils may be used.
 Woodward oil recommendations per manual 25071.

A serviceable external supply filter with a rating of (24 to 40) μm nominal β_{75} must be provided.
 ISO 20/16 Fluid cleanliness or better is recommended for optimum reliability.

Viscosity 20 to 100 centistokes

*If using the 25 bar model below 3.75 bar, please review the accuracy capability.

Performance

Dynamic Response

CPC-II Small Signal Step Response (Typical)

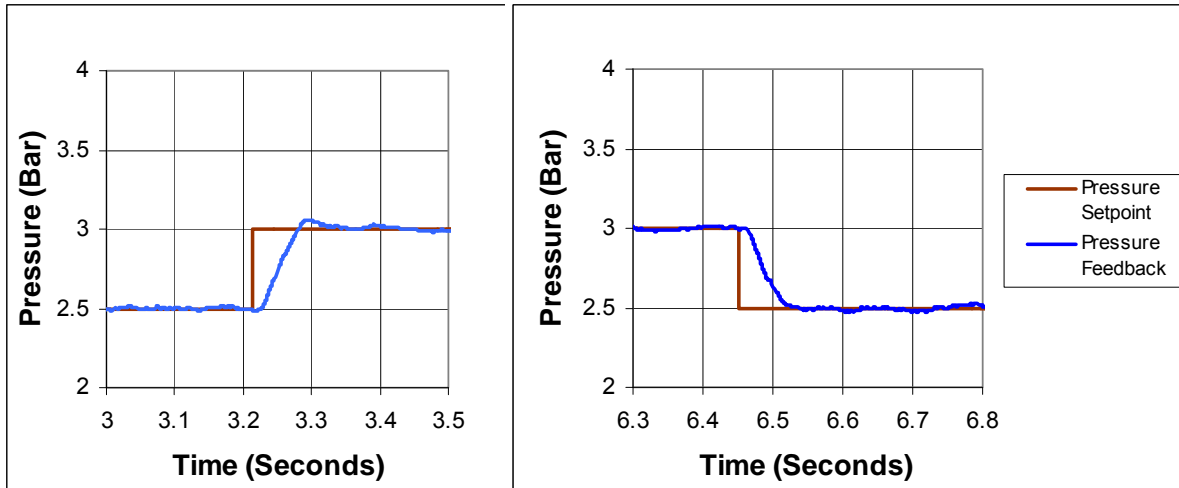

CPC-II Large Signal Pressure Response (Typical)

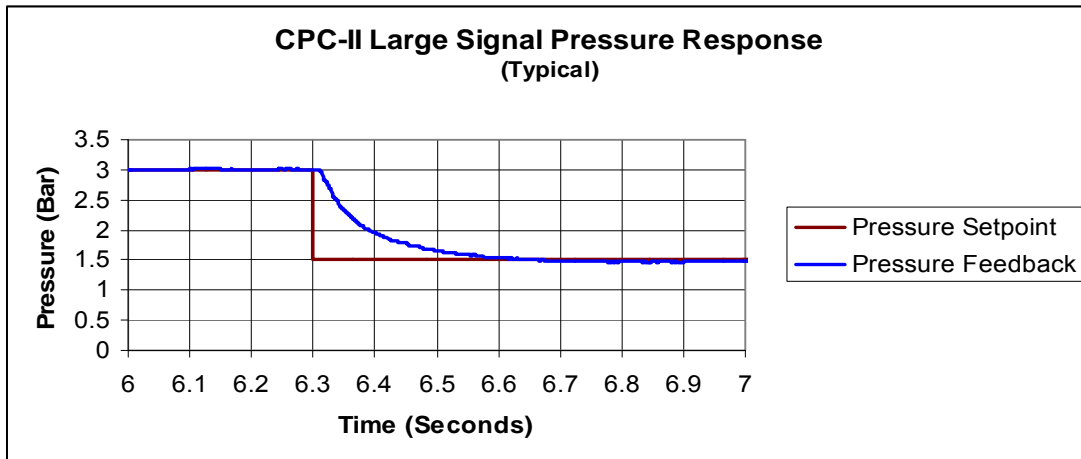

Figure 2-1. Pressure Responses

Flow Capacity

CPC-II Flow Capacity

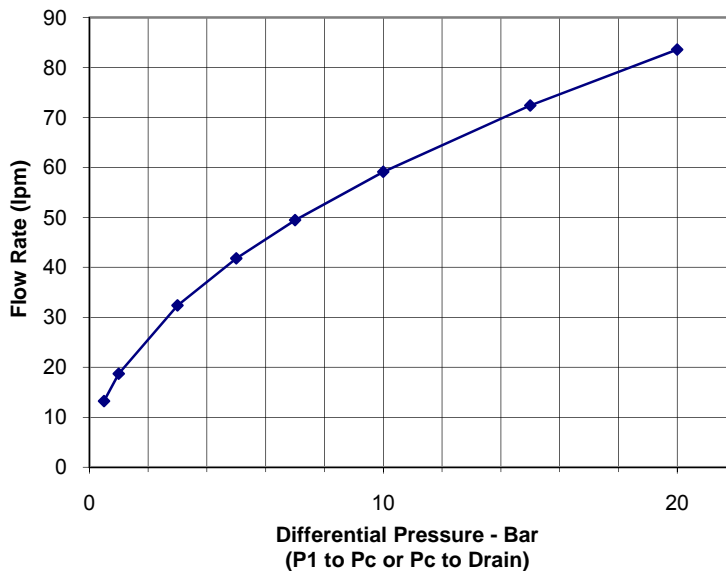

Figure 2-2. Maximum Flow Capacity

Pressure Stability	< ± 2 % of setpoint
Accuracy	< ± 0.2 % of full range
Temperature Drift	< ± 0.01 % full range / degree C

Environmental

Ambient Temperature	(-40 to +85) °C
Humidity	95 % relative humidity
Oil Temperature	85 °C max. continuous
Max. Surface Temperature	85 °C
Vibration	US MIL-STD 810F, M514.5A, Cat. 4 (0.015G ² /Hz, 10-500 Hz, 1.04 Grms)
Shock	US MIL-STD-810C method 516.2, procedure 1 (10 G Peak, 11 ms duration, saw tooth)
EMC	EN61000-6-2 (2005): Immunity for Industrial Environments EN61000-6-4 (2007): Emissions for Industrial Environments
Ingress Protection	IP56 per IEC EN 60529

Physical

Height x Width x Depth	Approx. (270 x 270 x 290) mm / (10.6 x 10.6 x 11.4) inch
Weight	Approx. 25 kg without oil
Mounting	Four M10x1.5 threaded holes, 16 mm deep, at the fluid interface

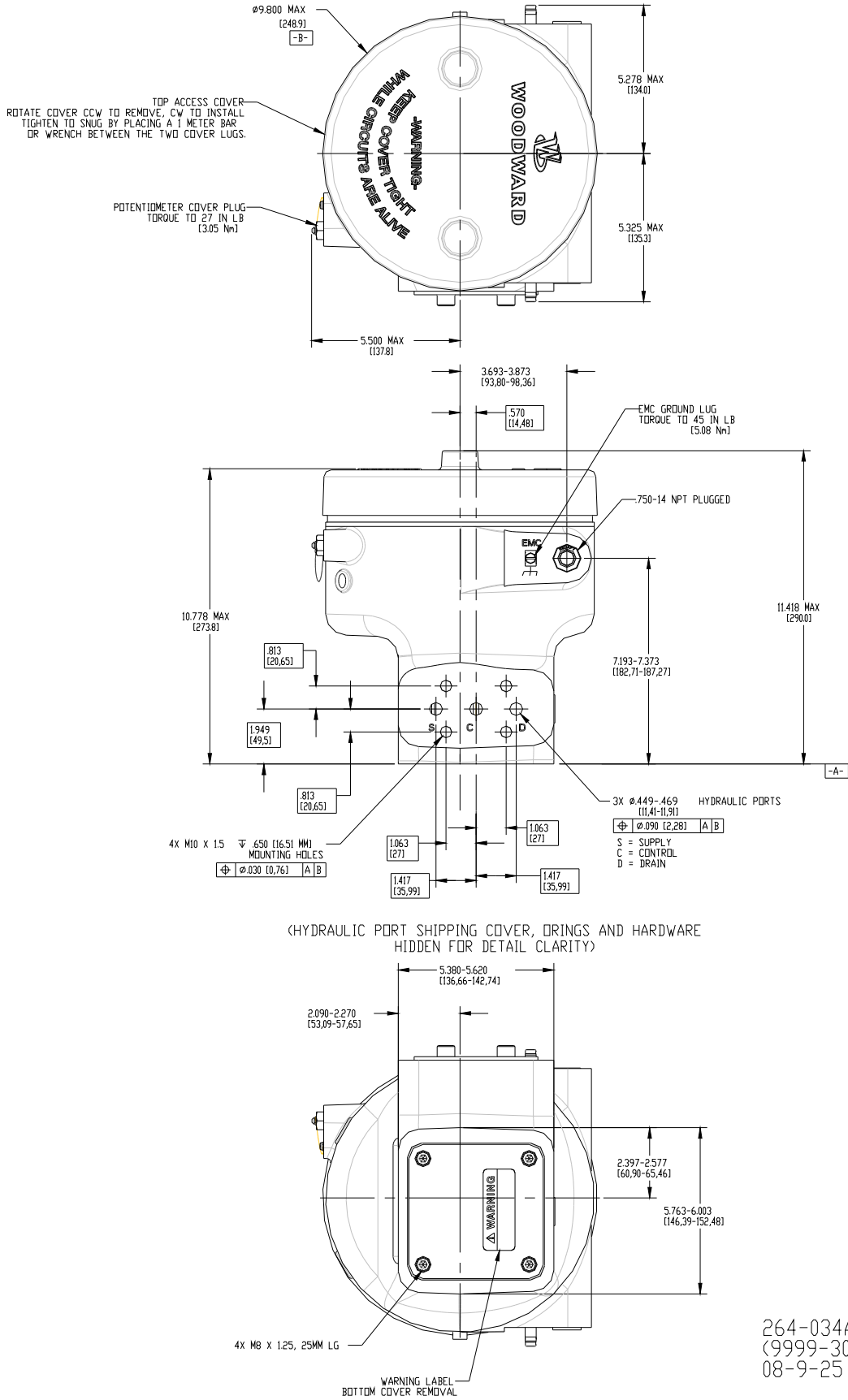

264-034A
(9999-3062)
08-9-25

Figure 2-3a. Installation Drawing

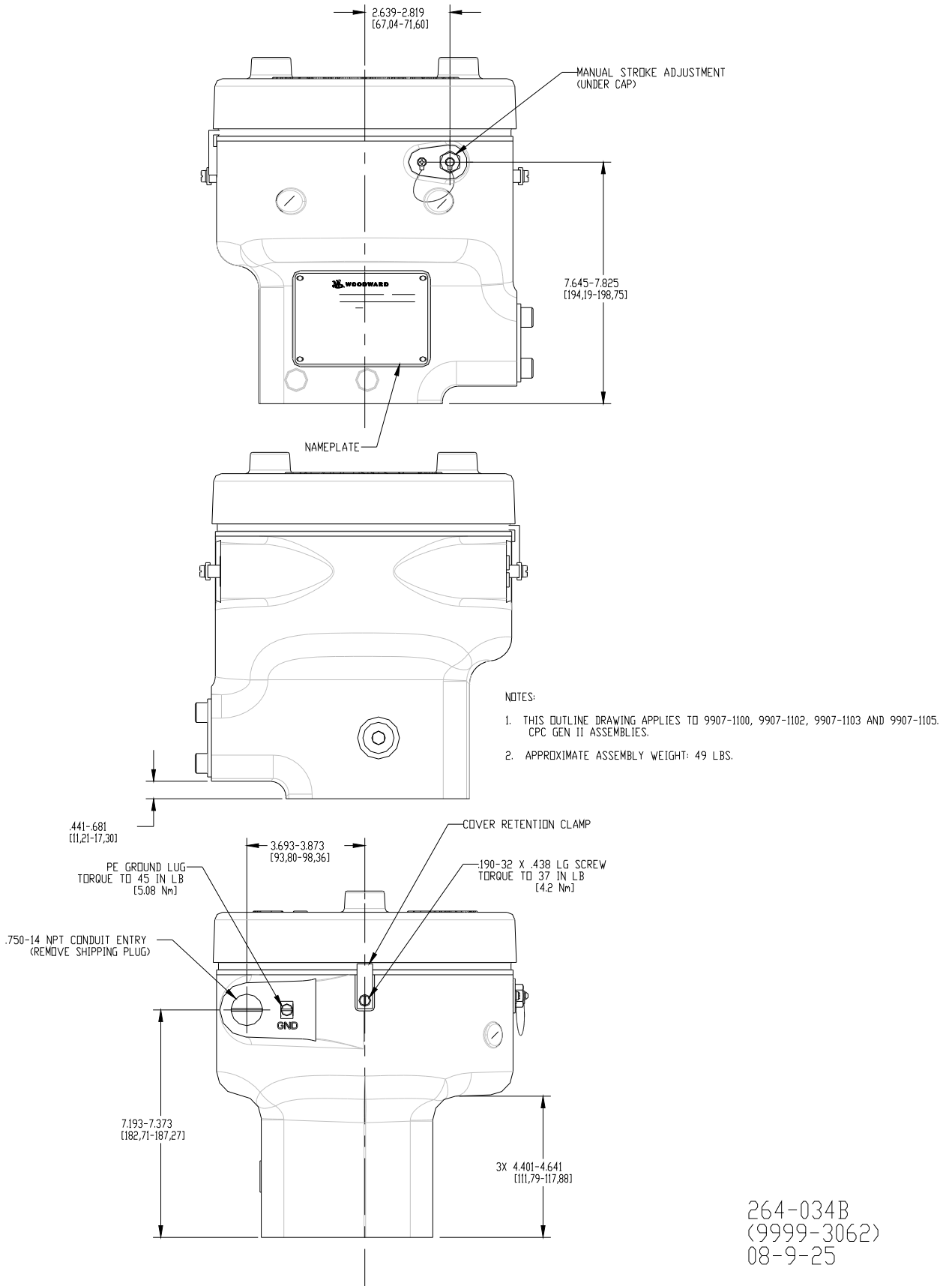

Figure 2-3b. Installation Drawing

Chapter 3. Installation

Receiving Instructions

The CPC-II is carefully packed at the factory to protect it from damage during shipping; however, careless handling during shipment can result in damage. If any damage to the CPC-II is discovered, immediately notify both the shipping agent and Woodward. When unpacking the CPC-II, do not remove the hydraulic blanking cover until you are ready to mount the unit.

Unpacking Instructions

Carefully unpack the CPC-II and remove it from the shipping container. Do not remove the blanking cover on the hydraulic interface until ready to mount.

**WARNING**

External fire protection is not provided in the scope of this product. It is the responsibility of the user to satisfy any applicable requirements for their system.

**WARNING**

Take care not to damage the cover seal, the cover surface, the threads, or the CPC-II surface while removing or replacing the cover.

**WARNING**

For Division 1/Zone 1 products: Proper torque is very important to ensure that the unit is sealed properly.

**CAUTION**

Due to typical noise levels in engine and turbine environments, hearing protection should be worn when working on or around the CPC-II.

**CAUTION**

The surface of this product can become hot enough or cold enough to be a hazard. Use protective gear for product handling in these circumstances. Temperature ratings are included in the specification section of this manual.

**CAUTION**

Do not lift or handle the CPC-II by any conduit. Use lifting straps fitted under the conduit bosses and the ledge above the nameplate.

Mounting Instructions

Location Considerations

When selecting a location for the CPC-II, consider the following:

- Provide adequate ventilation and avoid placing or attaching the CPC-II to heat generating parts of the installation.
- Locate the CPC-II as close as possible to the servo: short hydraulic lines (and volume) help to achieve optimum response.
- Avoid mounting the CPC-II where excessive vibration may occur.

Mounting the CPC-II

The CPC-II requires mounting to an adapter block (or plate) similar to that shown in Figure 3-1. The adapter block connects the three hydraulic ports on the CPC-II with the external oil supply, hydraulic drain, and control to the valve servo. The CPC-II is attached (clamped) to the adapter block by four M10x1.5 screws. The screws should engage the threads of the CPC-II for a minimum of 16 mm for a reliable and solid mounting. The interface should be designed with counterbores to accept face seal O-rings. This plate can be joined to the support structure using two M12 or larger screws or the manifold can be welded in place.

The CPC-II can be mounted in any attitude. However, for applications where oil contamination or entrained water is of concern, the recommended orientation is with the fluid ports facing downward.

Allow space for removal of the top cover, for access to the terminal blocks and to see the status LEDs on the printed circuit board.

Place the CPC-II against the adapter plate. Insure the O-rings are in place and secure the CPC-II to the manifold with the M10x1.5 screws and torque to a level appropriate for the tensile load of the fastener (Typical 60-80 N-m for Alloy Steel Socket Head Cap Screws with tensile area yield strength of 667 MPa). Be sure that the hydraulic ports are properly connected to the system: S to hydraulic supply, C to servo control pressure, T to hydraulic drain. Contact Woodward if a manifold/mounting plate is required.

Hydraulic Connections

The Supply pressure, Control pressure, and Tank/Drain connections on the CPC-II are made via a face seal manifold plate similar to that shown in Figure 3-1. S, C, and T are marked on the fluid interface of the CPC-II. An O-ring face seal interface should be provided as a feature of the manifold plate.

The inner diameter of the manifold plate and fluid lines should be large enough to prevent excessive pressure loss during transient flow conditions. The recommended inner diameter line size is 18 mm, the inner diameter should be no less than 12 mm.

The pump capacity should be large enough to supply the required slew rate of the attached servo system. Accumulators are generally not recommended for optimum performance. Some reduction in dynamic settings may be necessary if accumulators are used.

Before installing the CPC-II, the hydraulic lines, supply, tank, and the line from CPC-II to the controlled servo system, should be thoroughly flushed. A high capacity, serviceable filter is recommended upstream of the CPC-II supply port (see recommended hydraulic cleanliness).

When dual CPC-II's are used in a redundant arrangement. Each CPC-II should have an automatic shutoff valve controlled by the turbine control upstream of the supply port for isolation in case of failure. An open center pressure operated check valve or 3 way solenoid operated valve should be connected downstream of the CPC-II control ports so that only the unit "in-control" is hydraulically connected to the servo system.

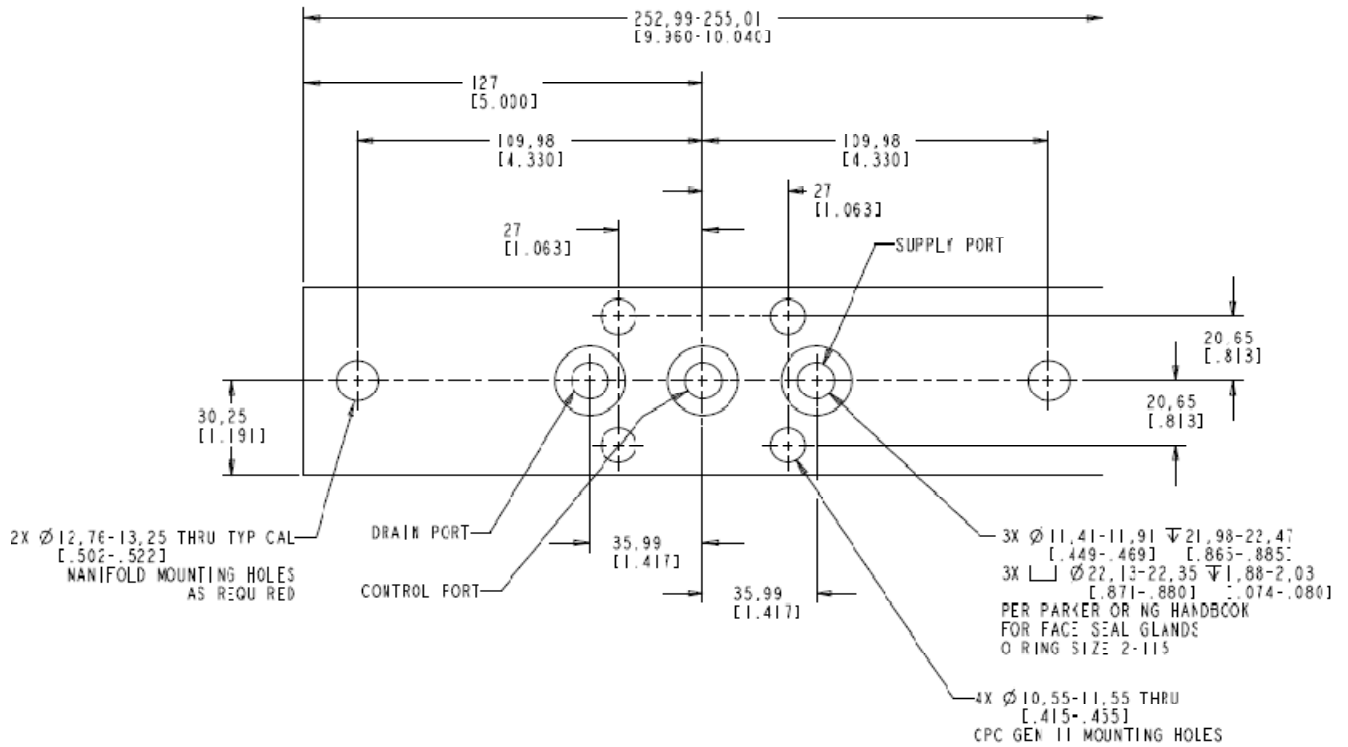

Figure 3-1. Example CPC-II Manifold Dimensions

Note: For replacement of Voith converters, see Chapter 8 for information on adapter manifold.

Electrical Connections

! WARNING

Due to the hazardous location listings associated with this product, proper wire type and wiring practices are critical to operation.

Conduit seals must be installed within 46 cm (18 inches) of the conduit entry when the CPC II is used in Class I, Division 1 hazardous locations.

Do not connect any cable grounds to “instrument ground”, “control ground”, or any non-earth ground system. Make all required electrical connections based on the wiring diagrams (Figures 3-4 and 3-5).

An overall electrical wiring diagram is shown in Figure 3-2. Detailed wiring requirements for these connections follow in the remainder of the Electrical Connections section. RS-232 wiring is covered in Chapter 4.

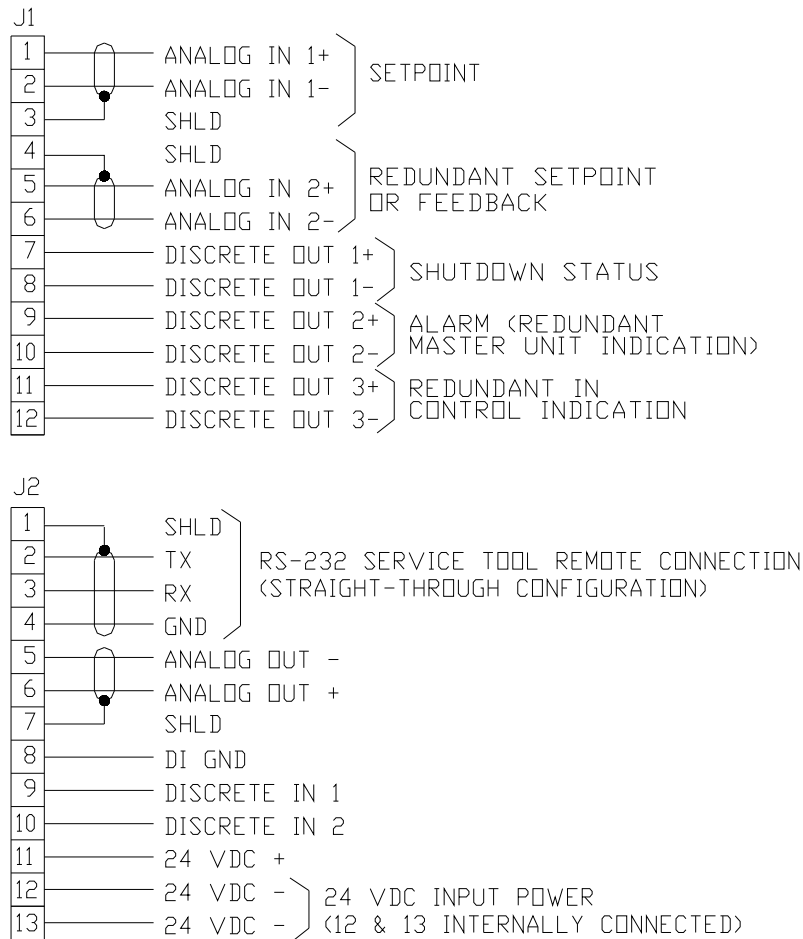

SERVICE TOOL INTERFACE

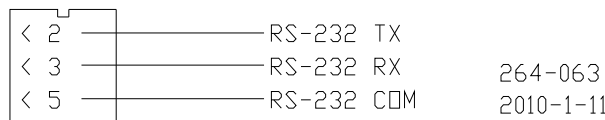

Figure 3-2. Wiring Diagram

Input Power

The CPC-II requires a power source capable of supplying the necessary output voltage and current at full transient conditions. The maximum power in watts (W) of a dc source can be calculated by taking the rated output voltage times the maximum output current capability at that voltage. The calculated power rating of the supply should be greater than or equal to the CPC-II requirements. The electrical power supply should be able to provide 2 A at 24 V (dc) continuously, with a peak of 5 A for two seconds.

The CPC-II is not equipped with input power switches. Some means of switching input power to the CPC-II supply must be provided for installation and servicing. A circuit breaker meeting the above requirements or a separate switch with the appropriate ratings may be used for this purpose.

Refer to Figure 3-3 for recommended fuse ratings or circuit breakers.

Component	Input Voltage	Maximum Current	Maximum Power	Maximum Fuse/C.B. Rating
CPC-II	(18 to 32) V (dc), 24 V (dc) nominal	5 A	90 W (2 s)	6 A

Figure 3-3. Fuse/Breaker Requirements

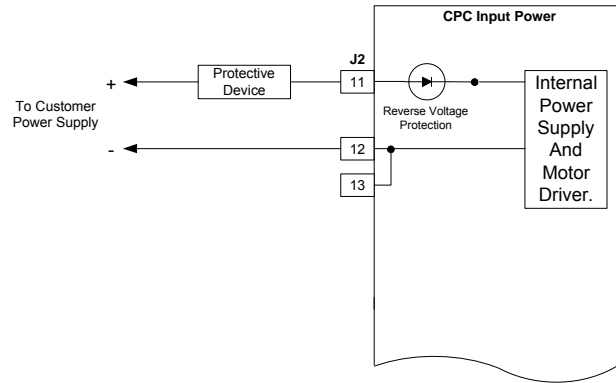

Figure 3-4. Power Supply Input Connections

Although the CPC-II is protected against input voltage transients, good wiring practices must be followed. The following drawing illustrates correct and incorrect wiring methods to the power supply.

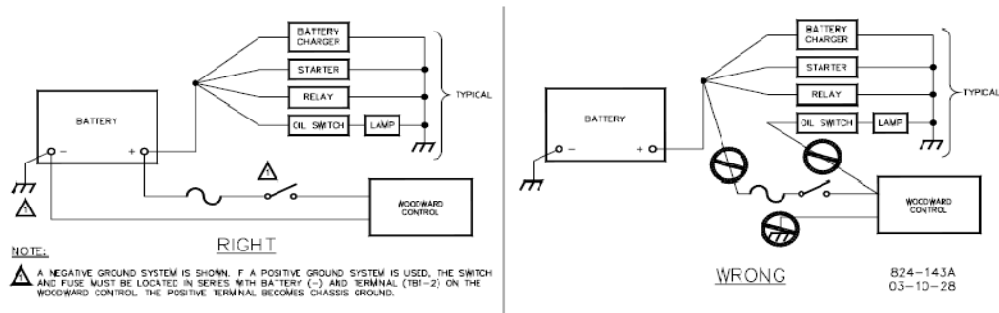

Figure 3-5. Correct and Incorrect Wiring to Power Supply Input

Wiring Requirements:

- Keep this input separated from low level signals to reduce signal noise
- Wire Gauge Range: (0.8 to 3) mm² / (12 to 18) AWG

Unit Grounding

The unit housing must be grounded using the designated PE ground connection point and EMC ground connection point (see Figure 2-3).

For the PE connection, use required type (typically green/yellow, 3 mm² / 12 AWG) as necessary to meet the installation safety ground requirements. For the EMC ground connection, use a short, low-impedance strap or cable (typically > 3 mm² / 12 AWG and < 46 cm / 18 inches in length). Torque the ground lugs to 5.1 N·m (3.8 lb-in).

IMPORTANT

In cases where the EMC ground configuration also meets the installation safety ground requirements, no additional PE ground is required.

Wiring Strain Relief

Tie down points and ratcheting tie wraps are provided to secure the wiring to the top of the PCB. This helps prevent wire strain from being transmitted to the connection at the terminal block and to keep the wiring from chafing on the cover when tightening and under vibration. Failure to secure the wiring could result in intermittent connections resulting in alarm or shutdown conditions.

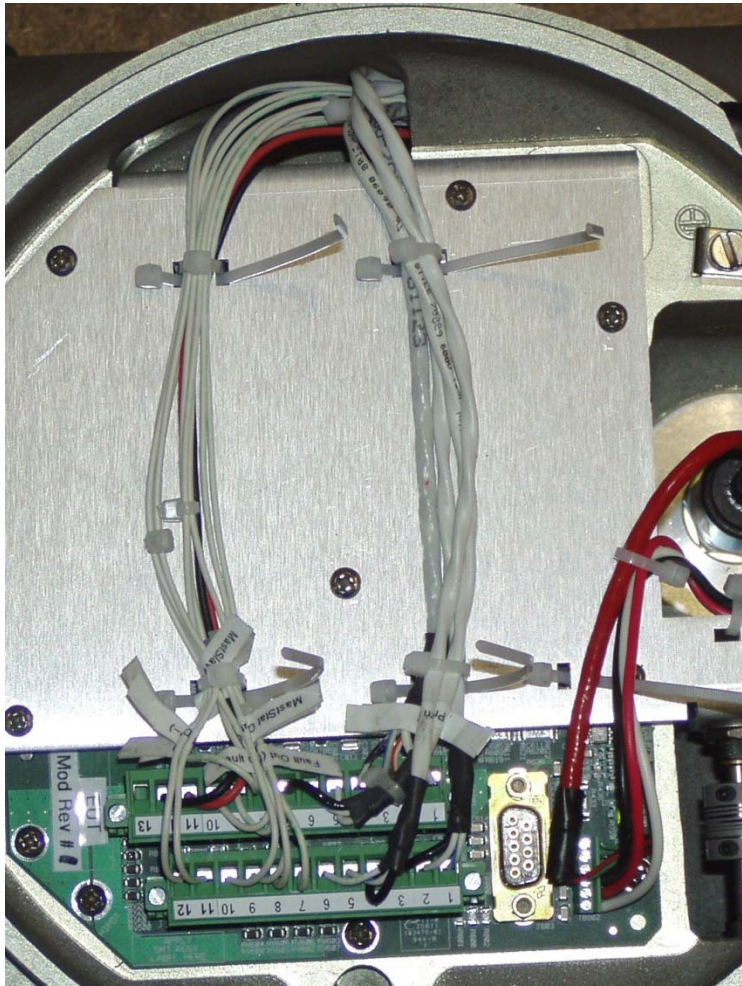

Figure 3-6. Recommended Wiring Strain Relief

Shielded Wiring

Use shielded cable for all analog signals and the RS-232 service port. Terminate shields as shown in the following sections. Avoid routing power supply wires and signal wires within the same conduit. When bundling the field wiring inside the unit, separate the unshielded power and discrete inputs/outputs from the shielded analog signals and RS-232.

Shield Installation Notes

- Wires exposed beyond the shield should be as short as possible, not exceeding 50 mm (2 inches).
- The shield termination wire (or drain wire) should be kept as short as possible, not exceeding 50 mm (2 inches), and where possible the diameter should be maximized.
- Installations with severe electromagnetic interference (EMI) may require additional shielding precautions. Contact Woodward for more information.
- Do not ground shield on both ends, except where permitted by the control wiring diagram.

Failure to provide shielding can produce future conditions which are difficult to diagnose. Proper shielding, at the time of installation is required to assure satisfactory operation of the product.

Analog Inputs

There are two analog inputs to the CPC-II. One is dedicated to the setpoint input. For applications where reliability is critical, the second analog input can be configured for a redundant setpoint input, or for a redundant pressure sensor input.

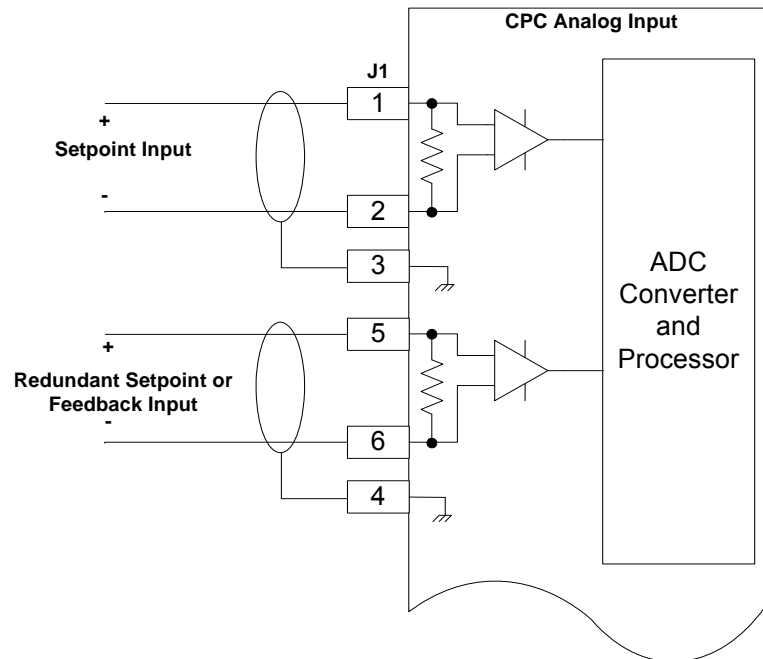

Figure 3-7. Analog Input Connections

Calibrated Accuracy: 0.1 % of full range
 Input Range: (0 to 25) mA, the recommended maximum range is (2 to 22) mA
 Maximum Temperature Drift: 200 ppm/°C
 Common Mode Voltage Range: ± 100 V
 Common Mode Rejection Ratio: 70 dB @ 500 Hz
 Isolation: 400 k Ω from each terminal to circuit common, 500 V (ac) to chassis ground

Analog input Wiring Requirements:

- Individually shielded twisted pair cable
- Keep this and all other low level signal cables separated from input power cables to avoid unnecessary coupling (noise) between them.
- Wire Gauge Range: (0.8 to 3) mm² / (12 to 18) AWG
- Shielding: per drawing above

Redundant Pressure Transducer Requirements:

- Calibrated Accuracy: 0.15 % of full range
 - Output Range: (4 to 20) mA
 - Maximum Temperature Drift: 100 ppm/°C
 - Dynamic Response : < 1 ms
 - Load Range: 250 to 500 Ω (for output up to 20 mA)
 - Recommended Ranges:
 - 0–10 bar for use with 0–10 bar CPC-II's
 - 0–25 bar for use with 0–25 bar CPC-II's
- Note:** Individual scaling is provided to accommodate ranges, which might differ somewhat from those recommended above.

Manual Stroke Potentiometer

An internal potentiometer is provided for Manual testing and verification of the CPC-II during commissioning or troubleshooting. The potentiometer is accessible under the cap on the front of the unit.



Figure 3-8. Manual Test Adjustment (shown with cover in place)

WARNING

The engine, turbine, or other type of prime mover should be equipped with an overspeed shutdown system to protect against runaway or damage to the prime mover with possible personal injury, loss of life, or property damage.

The overspeed shutdown system must be totally independent of the prime mover control system. An overtemperature or overpressure shutdown system may also be needed for safety, as appropriate.

The prime mover must be shut down and in a safe operating condition prior to testing of the CPC-II using the manual test function should be performed. A safe operating condition requires that the analog setpoint signals also be shutdown, which enables the manual stroke potentiometer.

To use the manual test function, the machine must be in a shutdown state but with the hydraulic supply pressurized. The setpoint signals must be at 4 mA or lower for the manual function to be enabled.

When the machine is in a safe ready state, remove the protective cover using a 12 mm wrench. Insert a flat-blade screwdriver to engage the slotted adjustment shaft. Turn the shaft fully counter clockwise to enable the manual stroke function. Wait 10 seconds for the permissive delay to elapse. Turn the shaft clockwise to the 2 o'clock position and wait for 3 seconds. The unit should now respond to the manual stroke position of the shaft.

Slowly move the shaft further counterclockwise. The pressure will correspond to the position of the shaft. Slowly move the shaft clockwise over the complete range of servo pressure. Ensure that the changes are smooth and that there is no evidence of large oscillation. If the range of pressure does not correspond to the required servo range, see Chapter 6 for instructions on scaling of the unit.

It is advised, but not required that the potentiometer be returned to the full counterclockwise position when manual testing is complete. The unit will resume automatic control whenever either setpoint exceeds 4 mA.

Re-install the dust cover when manual testing is complete.

Analog Outputs

The analog output of the CPC-II is in the form of a (4 to 20) mA output and can drive load resistances from 0 up to 500 Ω . This output can be configured to perform one of many different tasks, such as reporting, pressure feedback, pressure setpoint, and internal valve position. Refer to the service tool chapter for configuration information. This output is designed for monitoring and diagnostic purposes only, and is not meant for any type of closed loop feedback.

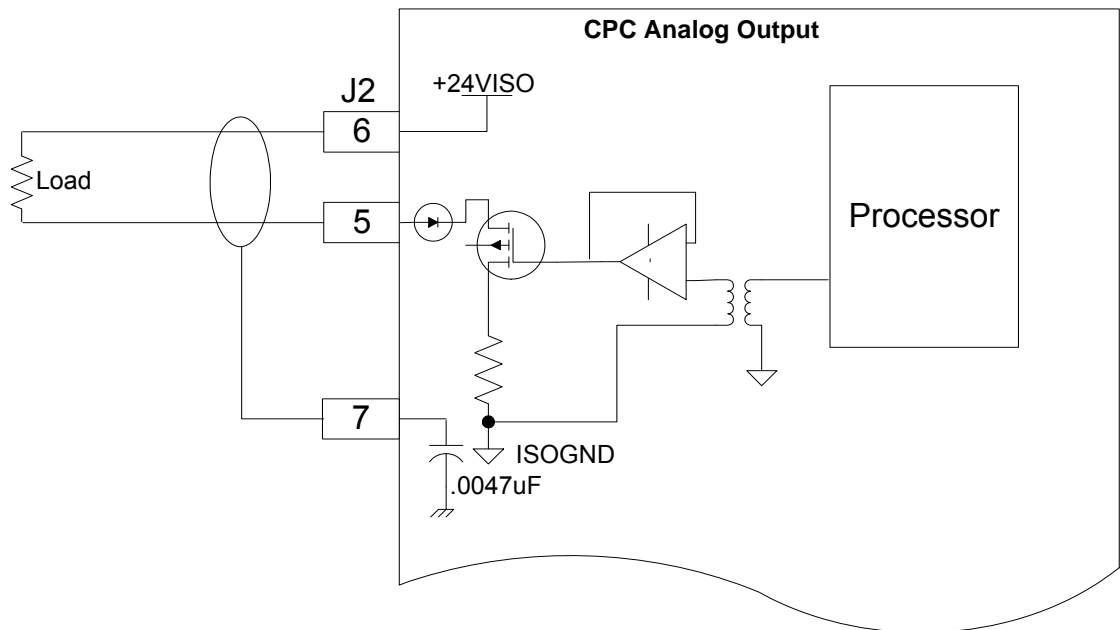

Figure 3-9. Analog Output Connections

For redundant configurations, it is highly recommended that the analog output be used. Should the discrete output wiring fail, or in the remote case of failure of the discrete output, the unit in control can still be determined by inspection of the analog output signal.

Calibrated Accuracy: $\pm 0.5\%$ of full range, (0 to 25) mA

Output Range: (2 to 22) mA

Load Range: 0 Ω up to 500 Ω (for output up to 25 mA)

Maximum Temperature Drift: 300 ppm/ $^{\circ}\text{C}$

Isolation: 500 V (ac) from circuit common, and chassis

Wiring Requirements:

- Individually shielded twisted pair cable
- Keep this and all other low level signal cables separated from input power cables to avoid unnecessary coupling (noise) between them.
- Wire Gauge Range: (0.8 to 3) mm² / (12 to 18) AWG
- Shielding: per drawing above

Discrete Inputs

The CPC-II has two discrete inputs. External power is not necessary for these inputs as the isolation is provided internally. The discrete inputs have an internal pull-up resistor and are inverted at the processor, such that an open circuit is the passive low state. The high state is achieved when the input is pulled low by an external contact to the isolated ground terminal provided. There are two inputs and one ground terminal (DI GND) provided, so it is necessary to share the one ground if both inputs are used.

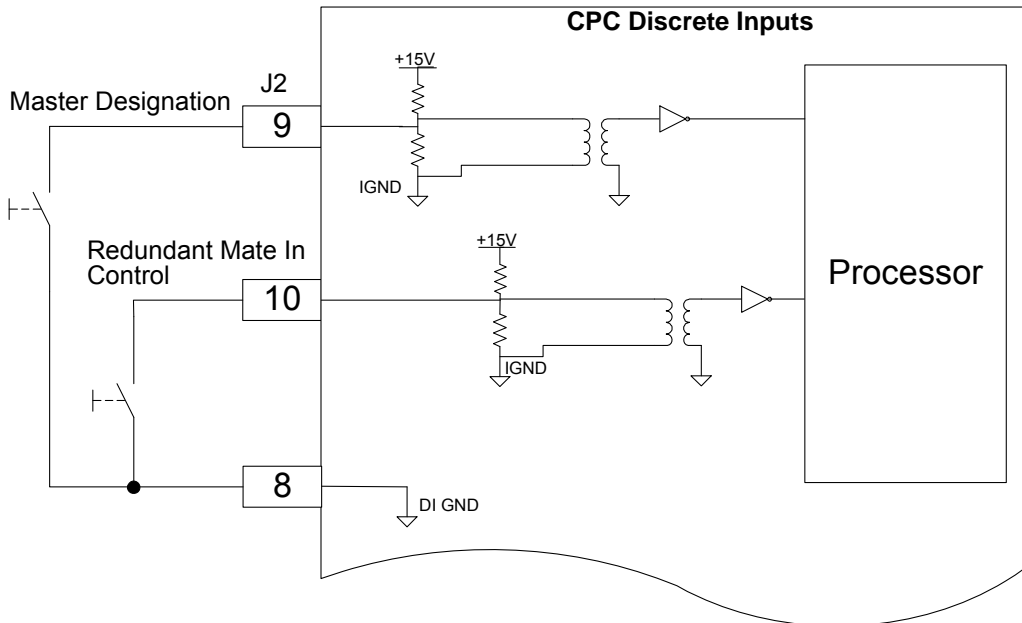

Figure 3-10. Discrete Input Connections

Discrete Input 1, Master Designation Input determines if the CPC-II is the master or slave in a redundant configuration. Refer to the section describing redundant control operation and wiring.

Discrete Input 2, Redundant Mate In Control is dedicated to redundant. The two CPC-II's communicate which unit is in control via a pulse train on these discrete lines. Discrete Input 2 should be wired Discrete Output 3 of the other unit.

Trip Points:

- If the input voltage is less than 3 V the input is guaranteed to detect a high state.
- If the input voltage is greater than 7 V the input is guaranteed to detect a low state.
- The open state will look like a low state to the controller, and, therefore the two states of the input are open or tied to ground.
- The hysteresis between the low trip point and the high trip point will be greater than 1 V.

Contact Types: The inputs will accept either a dry contact from each terminal to ground or an open drain/collector switch to ground. Approximately 3 mA is sourced from the input for dry contact operation.

Isolation: 500 V (ac) from Digital Common and chassis.

Wiring Requirements:

- Keep this and all other low level signal cables separated from input power cables to avoid unnecessary coupling (noise) between them.
- Wire Gauge Range: (0.8 to 3) mm² / (12 to 18) AWG

Shielding: this output is unshielded, however the wires should be kept in a twisted configuration for noise immunity.

Discrete Outputs

There are three Discrete Outputs on the CPC-II. The outputs can be configured as normally open/normally closed. Refer to the service tool chapter for configuration information. The outputs can be wired to switch load from positive supply or switch load to ground. Woodward recommends that the output be used as a high side driver as shown in the diagram below. This configuration will make some common wiring faults to ground more detectable in the user system. The user must supply the external 24 V supply for the output to function properly.

Discrete Output 1: Alarm or Shutdown Status. This output is dedicated to the fault status of the CPC-II.

Discrete Output 2: If CPC-II is in simplex mode, it can be used for alarm indication or for a redundant shutdown contact. If a open contact at the CPC-II discrete output will elicit a system shutdown from the main control, additional reliability can be achieved by using both discrete outputs and configuring them to annunciate shutdown faults. In this case the controller must be configured such that both contacts must indicate a fault condition prior to shutdown.

In redundant mode, Output 2 is used for master indication back to the turbine control or annunciation lamp.

IMPORTANT

- When used in a dual redundant arrangement, the Slave CPC-II will take control if it detects that a fault has occurred in the Master. In this situation, Discrete Output 2 will change state.
- It is recommended that the main turbine control be able to detect this change of state and annunciate the automatic transfer.

Discrete Output 3: This output is dedicated to redundant operation. It outputs a pulse train to the other CPC-II communicating which unit is in control and the presence of any internal fault conditions. Discrete Output 3 should be wired to the other CPC-II's Discrete Input 2 (Redundant Mate In Control).

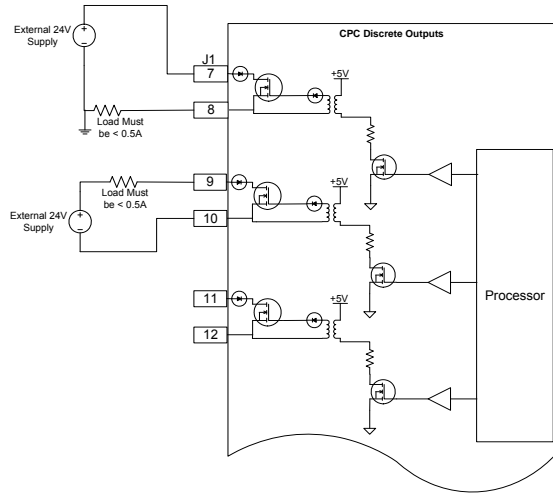

Figure 3-11. Discrete Output Connections

Hardware Configuration Options: The outputs can be configured as high-side or low-side drivers, but the recommended configuration is high side driver if possible.

External Power Supply Voltage Range: 18–32 V

Maximum Load Current: 500 mA

Protection:

- The outputs are short circuit protected
- The outputs are recoverable after short circuit is removed

Response Time: Less than 2 ms

On-state Saturation Voltage: less than 1 V @ 500 mA

Off-state Leakage Current: less than 10 μ A @ 32 V

Isolation: 500 V (ac) from digital common, 1500 V (ac) from input power

Wiring Requirements:

- Keep this and all other low level signal cables separated from input power cables to avoid unnecessary coupling (noise) between them.
- Wire Gage Range: (0.8 to 3) mm² / (12 to 18) AWG
- Shielding: this output is unshielded, however the wires should be kept in a twisted configuration for noise immunity.

Wiring

The CPC-II has two $\frac{3}{4}$ inch NPT wiring entries.

For Class I, Division 1 units, an Ex d stopping plug has been placed in the second conduit entry. For Class I, Division 2 and Zone 2 units, a $\frac{3}{4}$ "-14 NPT pipe plug has been placed in the second conduit entry. These plugs can be used or removed based on the user requirements for a second conduit entry.

When wired using cable and cable glands, the gland fitting must meet the same hazardous locations criteria as the CPC-II. Follow all installation recommendations and special conditions for safe use that are supplied with the cable gland. The cable insulation must have a temperature rating of at least 85 °C and 10 °C above the maximum ambient and fluid temperature.

1. Strip the cable insulation (not the wire insulation) to expose 12 cm of the conductors. Strip the wire insulation 5 mm from each conductor. Mark the wires according to their designation and install connectors, if required.
2. Remove the top access cover. Pass the wires through the cable gland (not provided) or conduit fitting and attach to the printed circuit board terminal blocks in accordance with the wiring diagram. Snap the terminal blocks into the header terminal blocks on the PCB. Tighten the terminal block flange screws to 0.5 N·m (4.4 lb-in).
3. Install the PE ground and EMC ground straps to the lugs provided. Tighten to 5.1 N·m (45 lb-in).



For Class I, Division 1 products: Conduit seals must be installed within 46 cm (18 inches) of the conduit entry when the CPC-II is used in Class I, Division 1 hazardous locations.

4. Tighten the cable gland fitting per manufacturer's instructions or pour the conduit seal to provide strain relief for the cable and to seal the interface between the wiring cable and the CPC-II.

Chapter 4. Installing and Running the PC Service Tool

Making the Hardware Connection

The PC Service Tool is a software application which runs on a Windows-based PC or laptop. It requires a physical RS-232 connection between the computer and the CPC-II. The physical connection can be made in one of two ways: connect to the CPC-II at the DB9 connector located next to the terminal block, or, if the cover must be in place during operation (hazardous locations), the RS-232 line can be routed through the gland fitting or conduit hub and connected at the J2 terminal block.

Use a straight-through serial cable (not null modem). For newer PCs or laptops with USB ports rather than serial ports, a USB-to-serial converter is required. An approved converter can be obtained from Woodward P/N 8928-1151.

Woodward offers a serial cable as a kit that can be ordered. The part number for this kit is 8928-7323, which contains a 10-foot long (3 m) DB9-F to DB9-M straight-through cable. Note that this cable has two nuts on the screws on the female end that need to be removed prior to installing this end.

NOTICE

Never connect the DB9 and the terminal block RS-232 connections simultaneously to one or more PCs or laptop computers. The CPC-II is protected, however damage may occur to the PC or laptop computer.

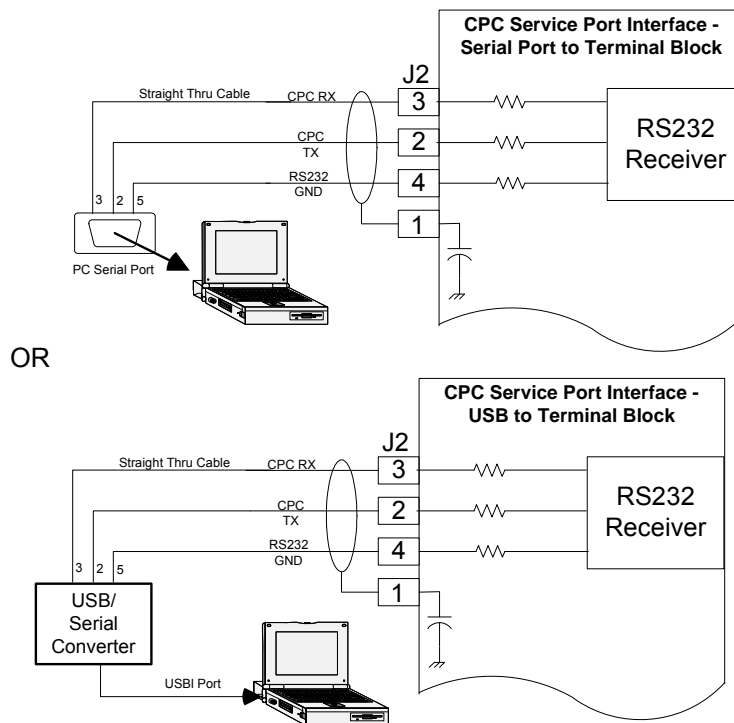

Figure 4-1. Service Port Connections

**WARNING**

Take care not to damage the cover seal, the cover surface, the threads, or the CPC II surface while removing or replacing the cover.

Damage to sealing surfaces may result in moisture ingress, fire, or explosion. Clean the surface with rubbing alcohol if necessary. Inspect the cover joint surfaces to ensure that they are not damaged or contaminated.

Locating and Installing the CPC-II Service Tool

The CPC-II is available from two locations. The first location is on the CD shipped starting with this manual revision. This CD is Woodward part number BCD85251. The second location is the software-download section of the Woodward website (www.woodward.com/software).

The PC Service Tool requires the Microsoft Windows 2000 or XP operating system. Two software components are required to allow the CPC-II Service Tool to run properly:

- Microsoft.NET Framework version 2.0 or higher
- Woodward Toolkit 3.0 or higher

Note that the CPC-II Service Tool Software will check for the above two components. If the CD is used, these will be loaded automatically off the CD. If the CPC-II Service Tool is downloaded from the Woodward Software Internet site, the user will be prompted to install these components from the site.

CD Program Installation

To start the installation, insert the BCD85251 CD into the laptop or PC disc tray and use the RUN icon from the START menu. Use the BROWSE tab to locate the following file and press "OK". The setup.exe file is located under the 9927-1571.CD directory. In the example, the D: drive is the CD drive. This might vary depending on computer configuration.

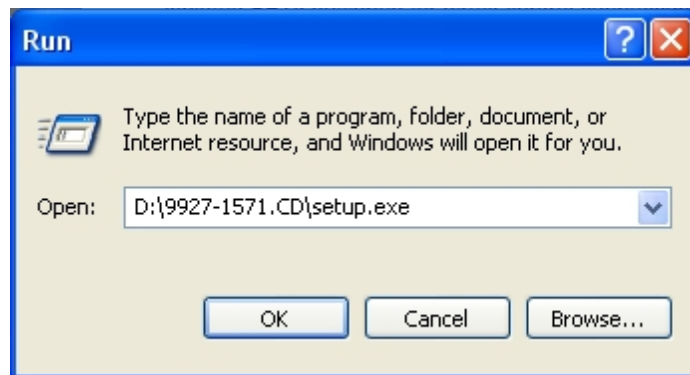

If the Laptop or PC does not have .NET Framework 3.5 installed, the following window will be displayed. This may take a couple of minutes. Review the agreement and then press “Accept”.

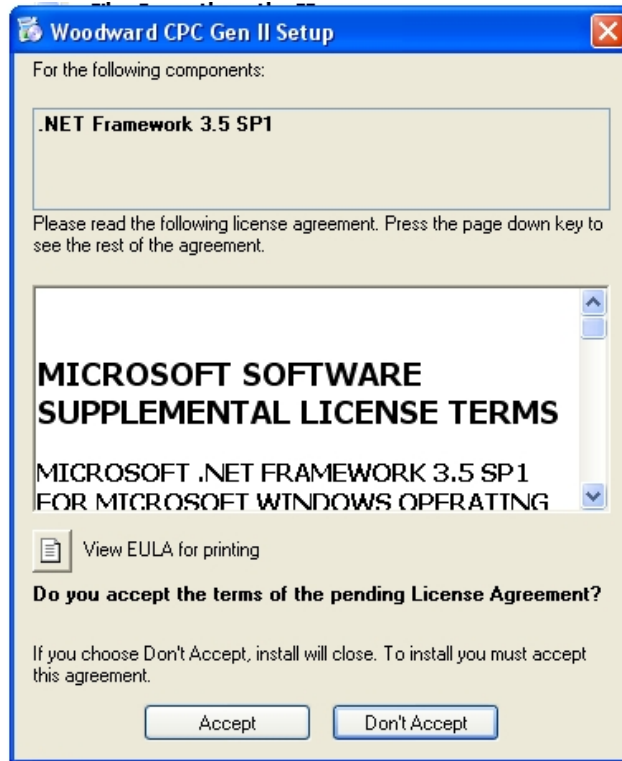

This window will then be followed by the license agreement for Woodward ToolKit 3.3 if it is not already installed. Review the agreement and then press “Accept”

The installation and configure process will now begin. This can take up to 5–7 minutes.

At first the required files are copied as indicated by the following screen:



Then the following screen will be displayed indicating that Framework is installing:

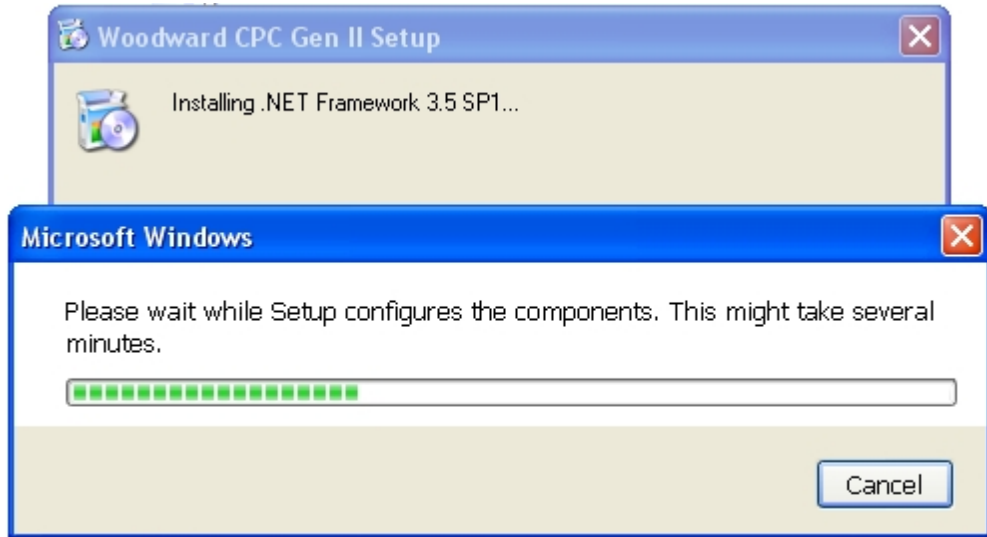

A similar screen will follow indicating that Woodward ToolKit is being installed.

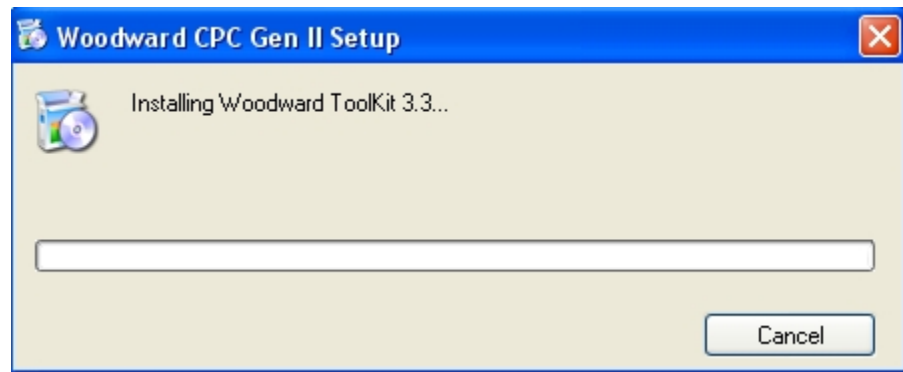

Once Framework and ToolKit are installed, the CPC-II Service Tool will next be installed. The following screen will appear: (Note that this will be the first screen if the computer already has Framework 3.5 and ToolKit 3.3 installed.)

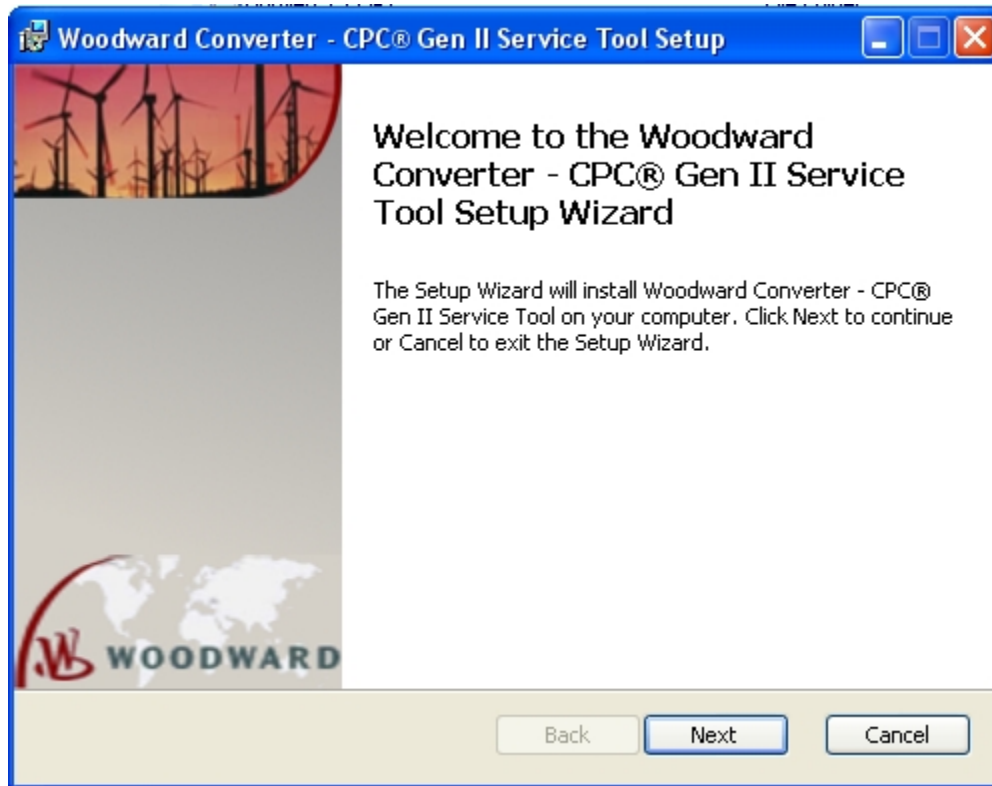

Press "Next" to get the License Agreement screen. Review the agreement and then check the Accept box followed by "Next".

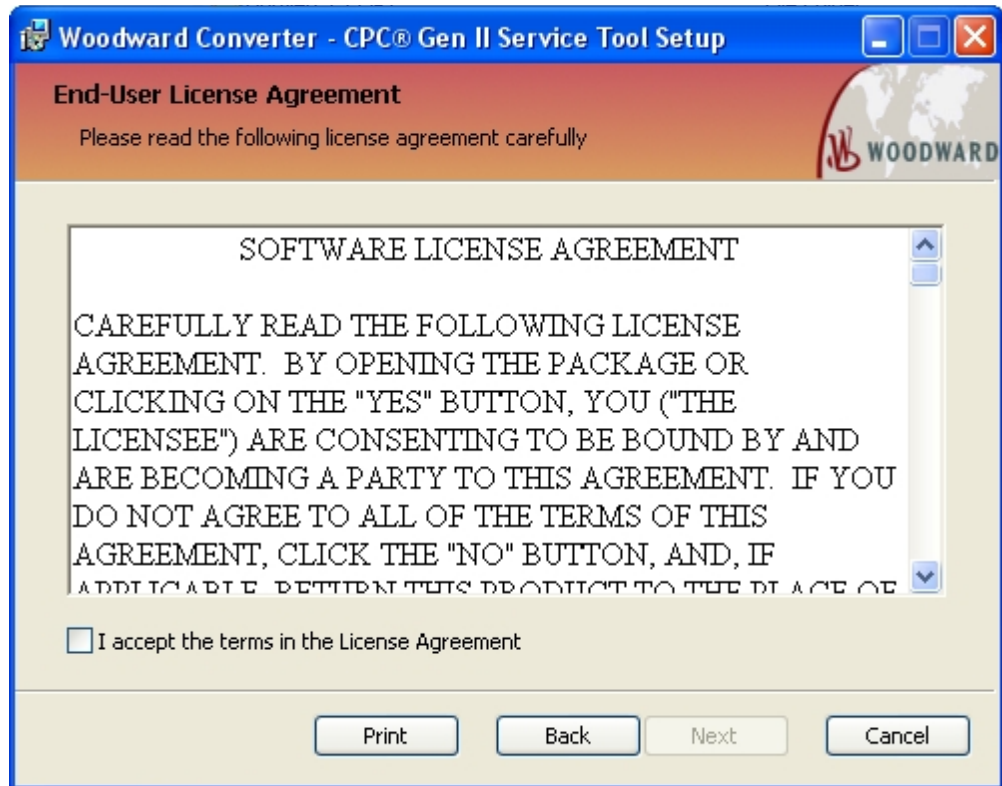

Press "Install" when the following screen appears.

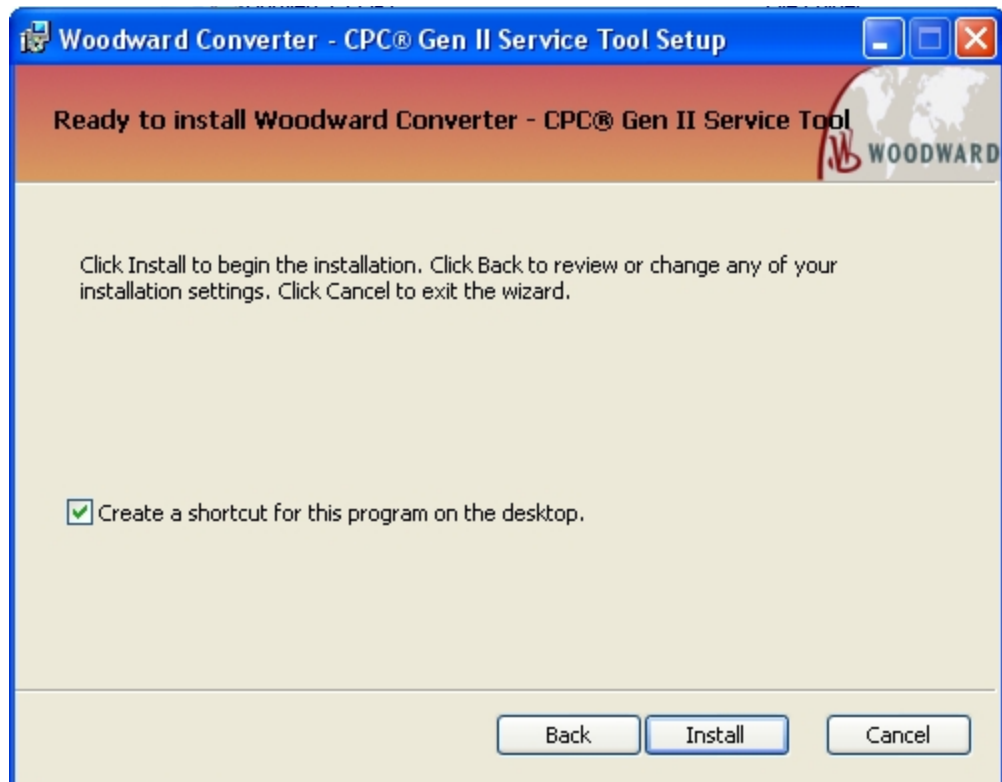

Press "Finish" to complete the SetUp. You can check the Launch box if you want to run the Service Tool when you press "Finish".



The CPC-II Software is now installed and is ready to run.

Obtaining the CPC-II Service Tool from the Internet

The software is located at the Woodward website that can be accessed by typing:

www.woodward.com/software

in your internet browser. Use the arrow in the Select a Product box to highlight the CPC-II Service Tool Selection and then select Go.

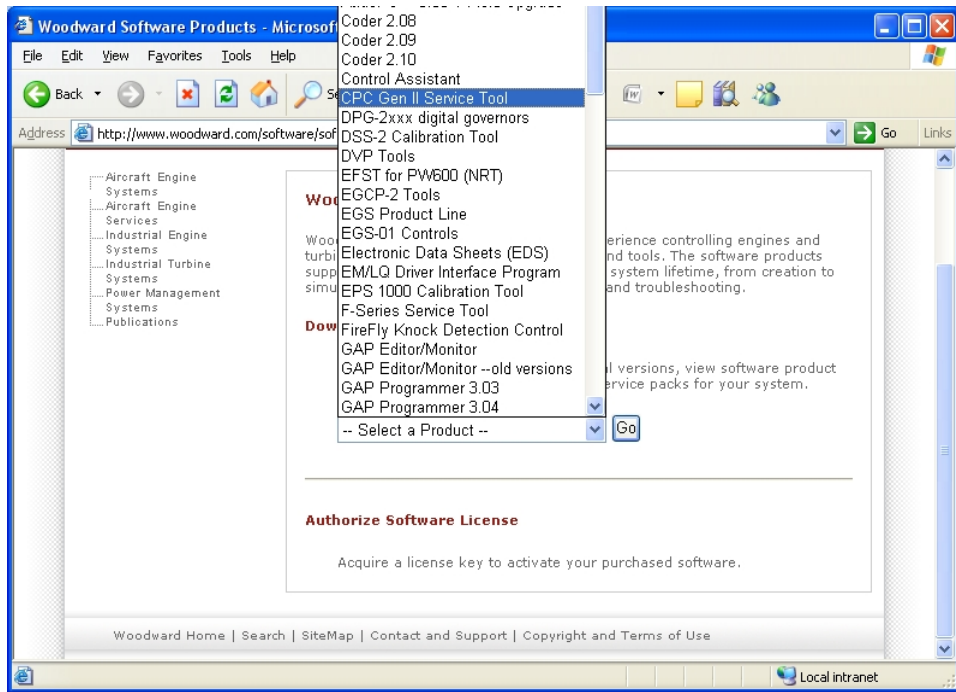

Select Download from the following screen.

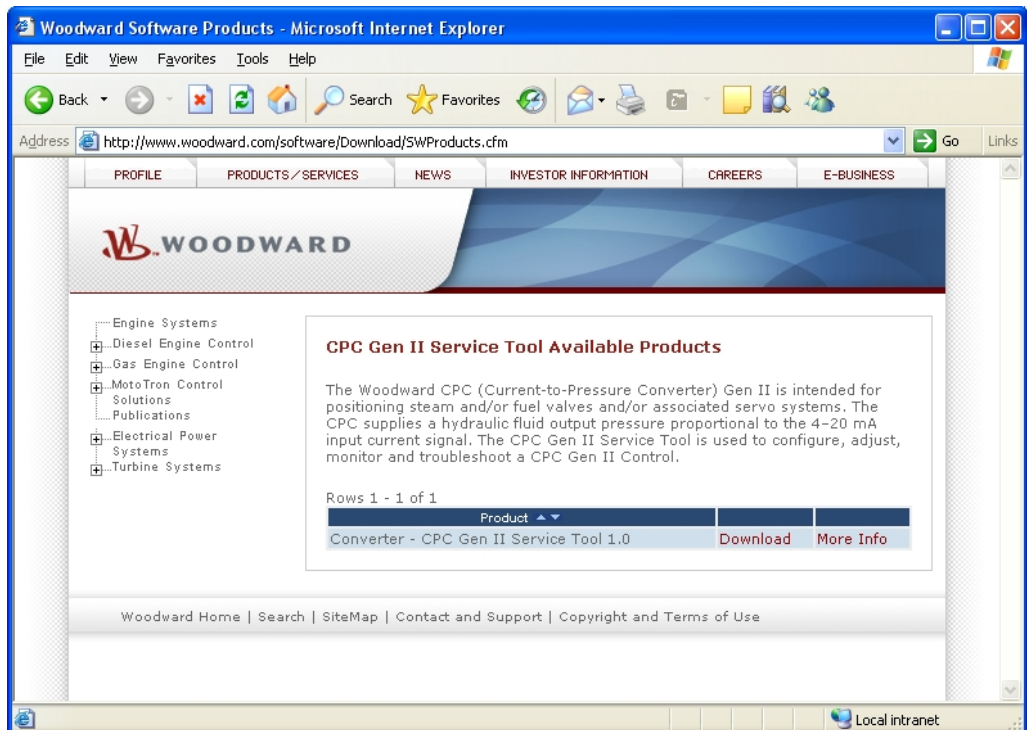

You will then be prompted to supply your Email address if you are already a registered user of Woodward' software. Otherwise, you will need to register.

Finally you will be prompted for a location to save the software.

To complete the installation you will then need to follow the steps listed in the CD installation above.

Running the CPC-II Service Tool

With the Installation complete, the Service Tool can be run by selecting Start followed by All Programs and the finding the Converter – CPC Gen II Service Tool item as shown below.

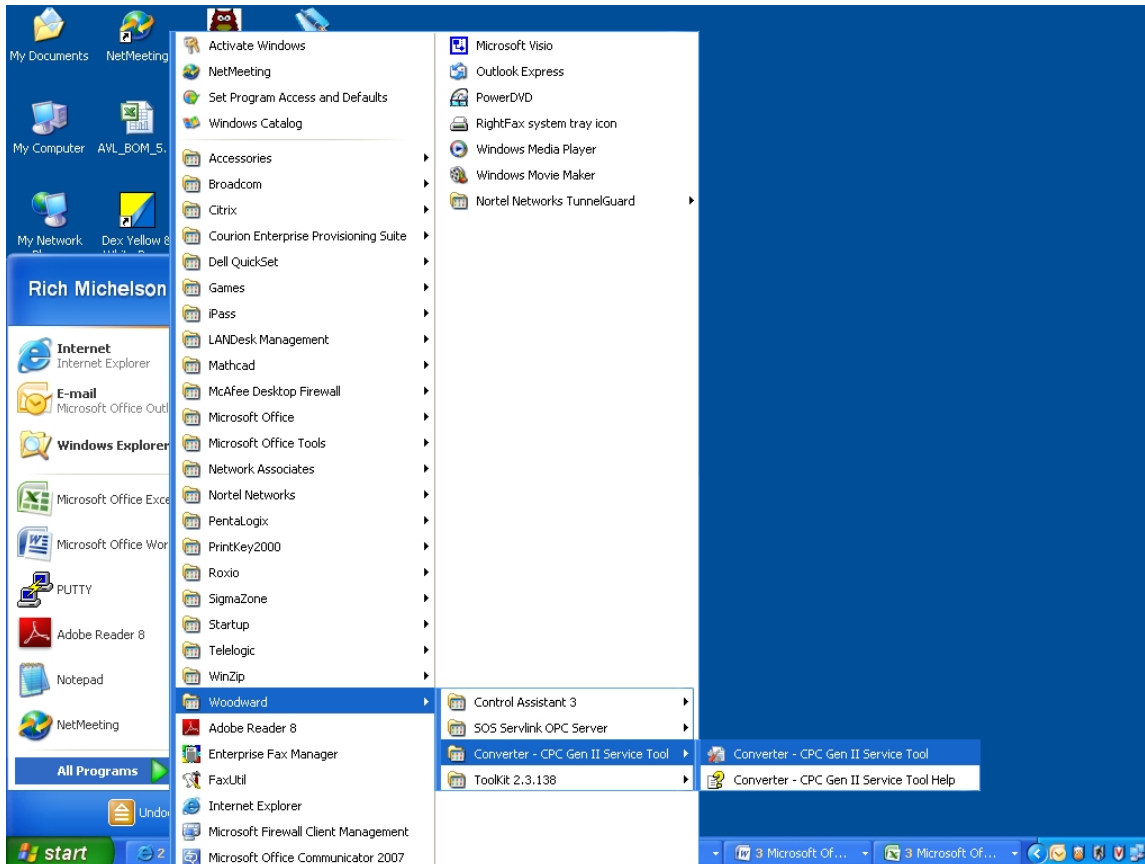

Once the Service Tool is running you will get a screen similar to the one below. In this screen, the “Connect” option has been highlighted and the connect options are displayed. Note that these options may vary from Laptop to Laptop. Select your available network and then set “Baud Rate” to “AutoDetection” as shown. Finally, select the “Connect” button to connect.

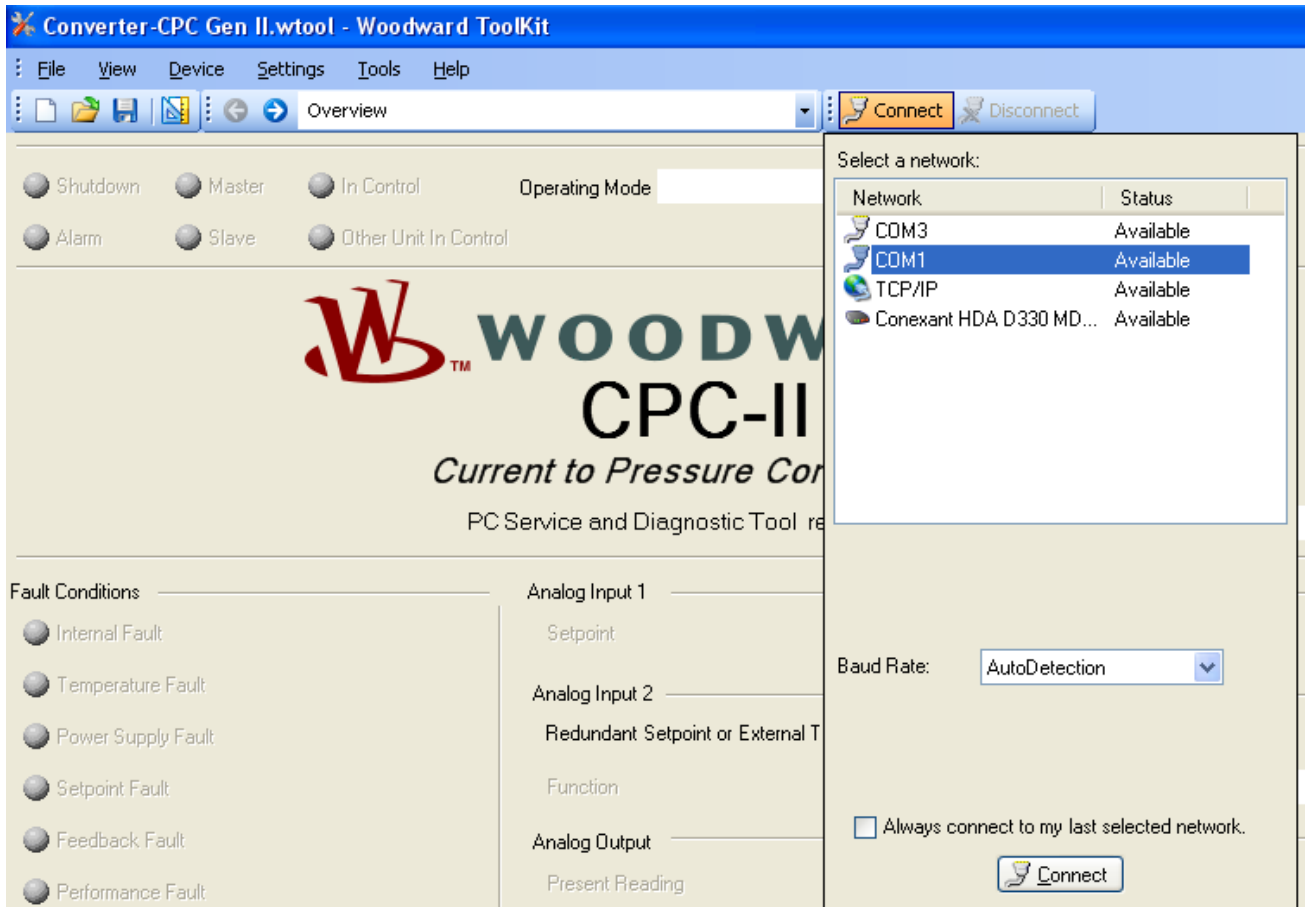

A screen similar to the one below will appear while the laptop attempts to connect to the CPC-II. If the screen remains in the connecting mode below, there is a problem in establishing communication. This could be a problem with the cable connections or possibly with selecting the wrong network (see above).

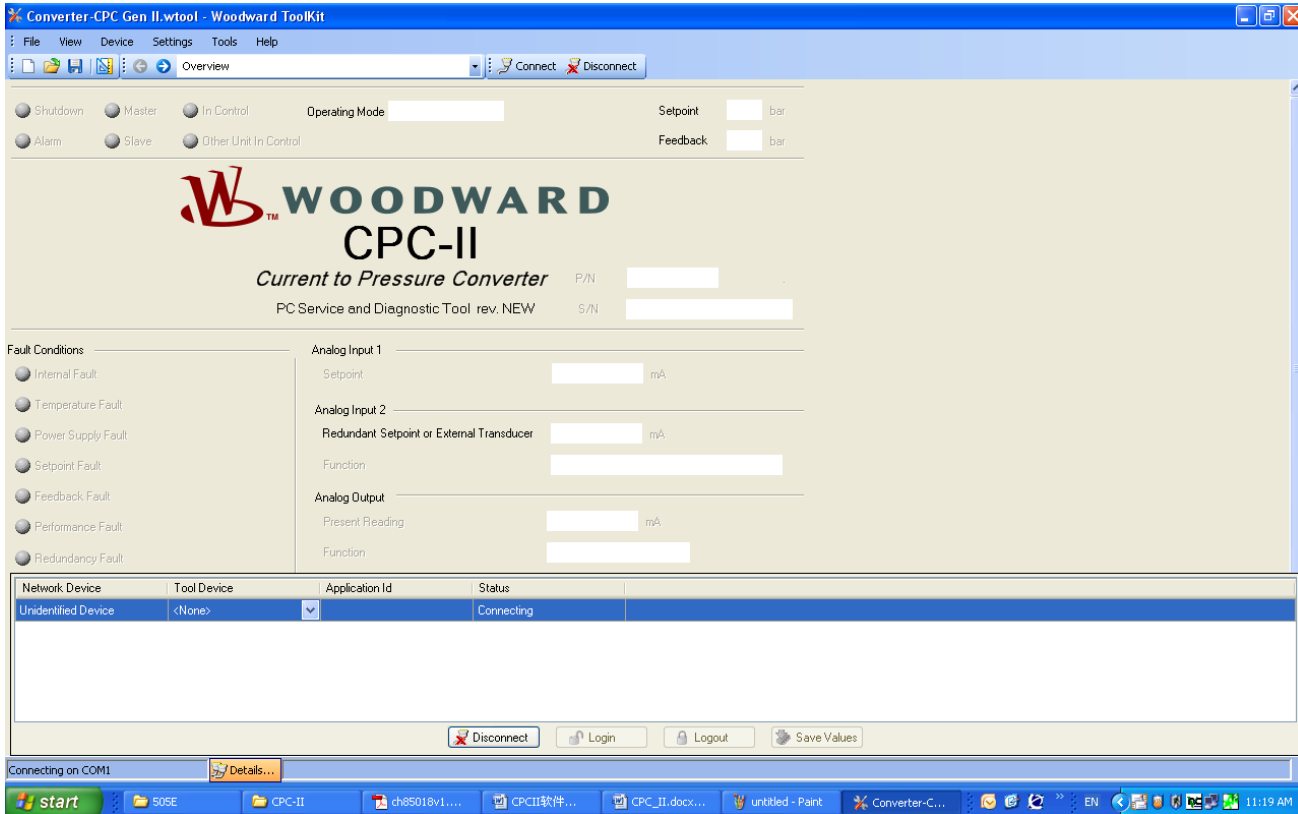

A successful connection will display a screen as shown below. Note the “Connected on COM1” above the green “start” key.

Once communication has been established, you are ready to proceed to the following chapter to use the Service Tool.

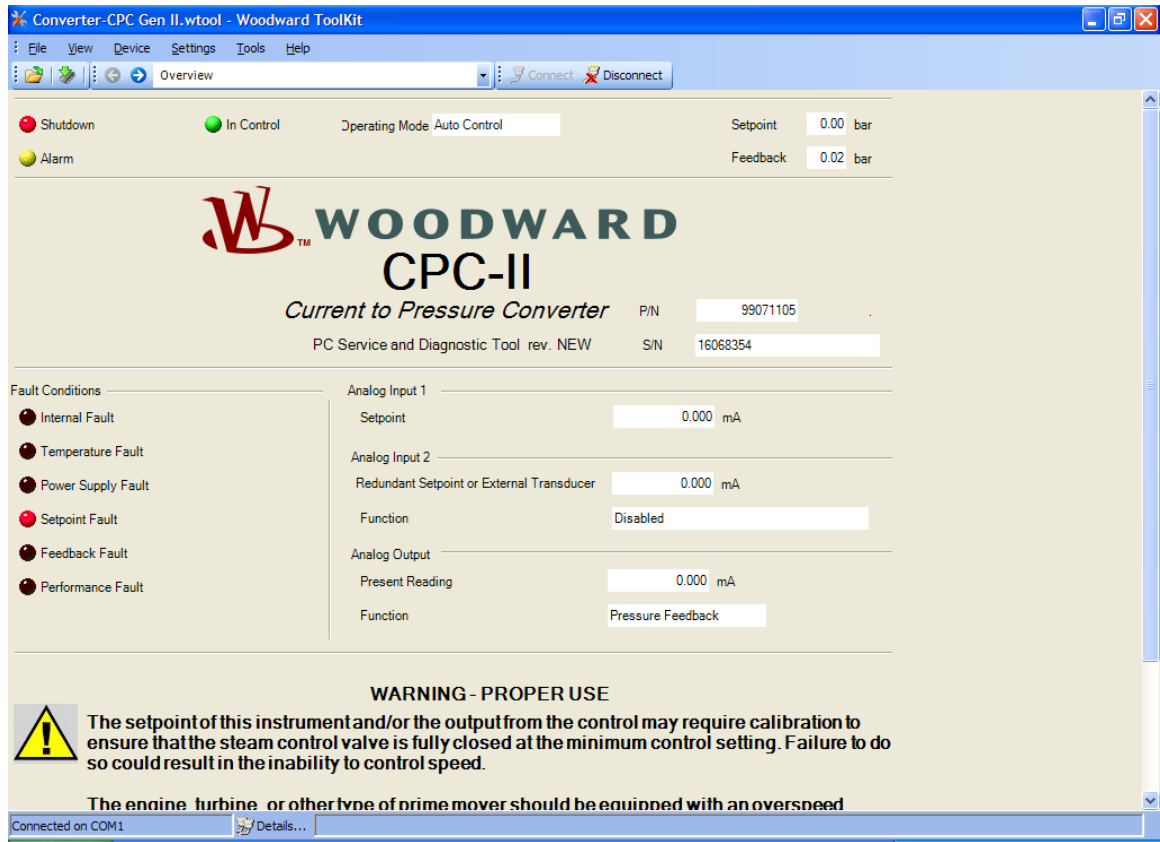

Chapter 5.

Using the PC Monitoring Tool for Performance Assessment and Tuning

Introduction

After installation, settings in the CPC-II must be set for proper operation using the PC Service Tool. For newer computers without serial ports, a USB to serial converter is required. Woodward provides an approved converter P/N 8928-1151. The following section includes information for proper verification of settings.

WARNING

The engine, turbine, or other type of prime mover should be equipped with an overspeed shutdown system to protect against runaway or damage to the prime mover with possible personal injury, loss of life, or property damage.

The overspeed shutdown system must be totally independent of the prime mover control system. An overtemperature or overpressure shutdown system may also be needed for safety, as appropriate.

WARNING

An unsafe condition could occur with improper use of these software tools. Only trained personnel should have access to these tools.

Product Overview

Shutdown	A shutdown condition has been invoked. The unit has detected an operating condition, which adversely affects the ability of the unit to operate reliably and predictably.
Alarm	The unit has detected an operating condition, which is outside of recommended operating parameters, but where operation is still possible. The cause of alarm conditions should be determined and corrected to prevent damage to the turbine, CPC-II, or other auxiliary equipment.
Master Slave	When redundant CPC-II's are used, the Master/Slave designation received from the control system and the status of which unit is in control is displayed in the header of each page. See Figure 5-2.
In Control	The unit is controlling within the edge limits defined by the analog input scaling. The "In Control" PID settings are active.
Other Unit in Control	The unit is controlling outside the edge limits defined by the analog input scaling, or the other unit is in control in a redundant unit arrangement. The "At Valve Limits (or Slave Mode) PID settings are active in this state.
Setpoint and Feedback Values	The current operating setpoint and measured pressure feedback values are displayed in the upper right panel of the page.
Part Number and Serial Number	The Part Number and Serial Number of the unit are displayed. Record these values if contacting Woodward for assistance.

Analog Input 1
 Analog Input 2
 Analog Output
 Values and
 Function

The current values received at each analog interface are displayed. These values can be compared to the values sent at the control, or by a multi-meter to verify proper calibration. In addition the configured function for the 2nd analog input and analog output are displayed. To modify the configuration of the analog input and/or analog output, see the configuration section.

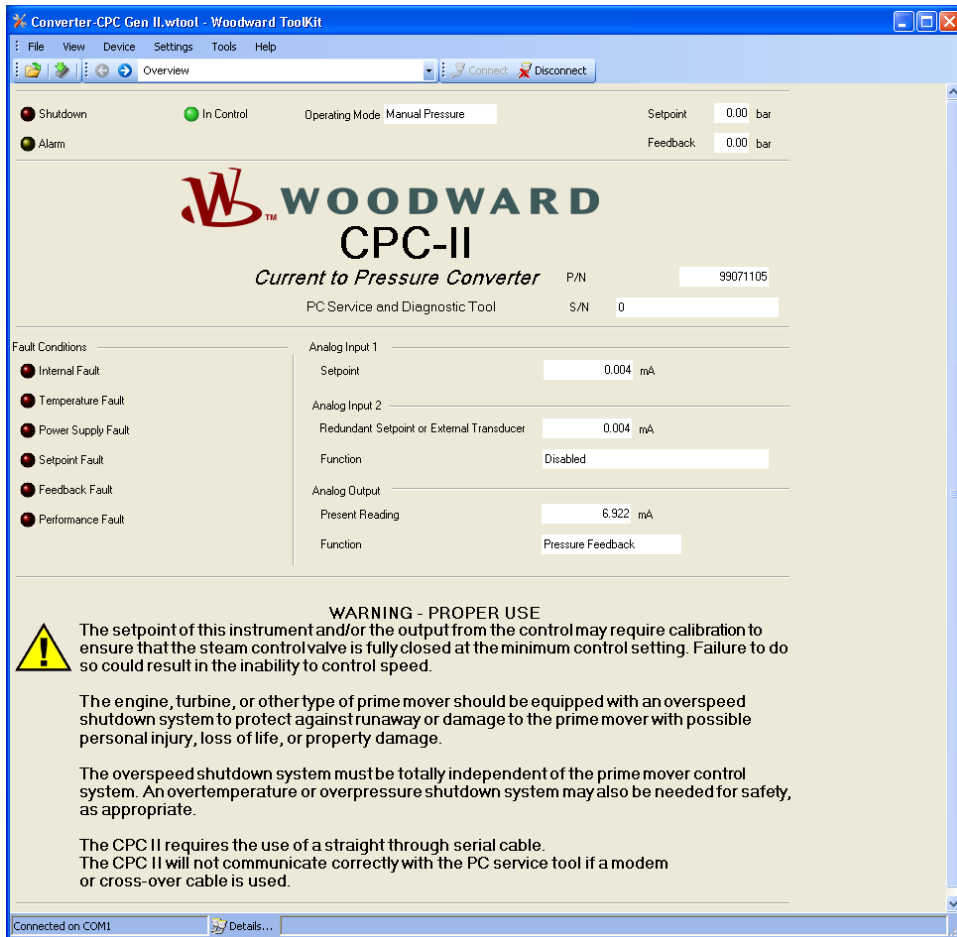

Figure 5-1. PC Service Tool Overview Screen

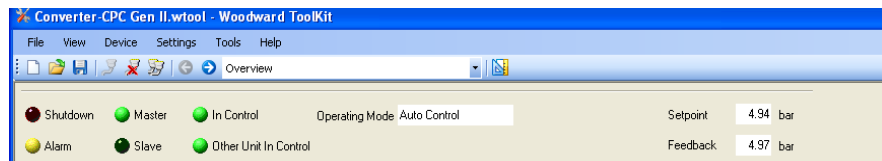

Figure 5-2. Service Tool Header for Redundant Units (showing Master/Slave Status)

Performance Trend and Manual Operation

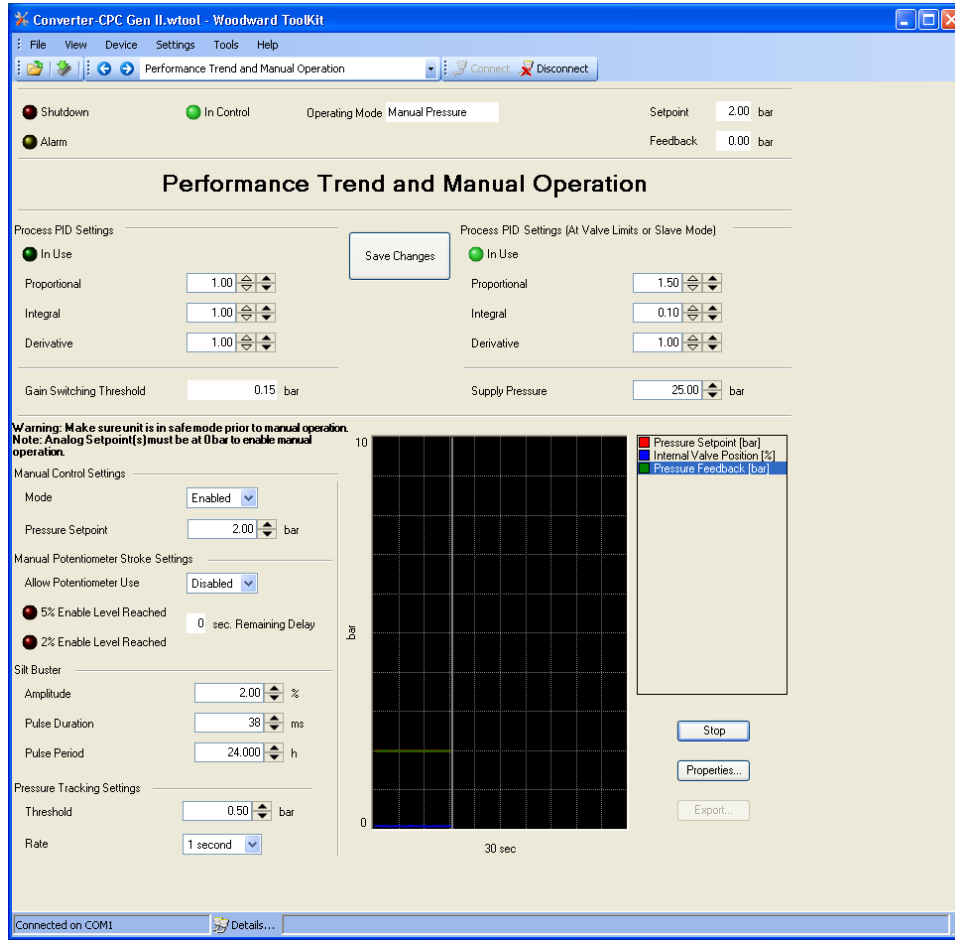

Figure 5-3. PC Service Tool Performance Trend and Manual Operation Screen

Process PID Settings

Dynamic adjustments needed to tune the CPC-II for various operating conditions

Proportional Gain

This adjustment sets the amount of proportional action for the pressure control loop. In most cases, the values can be set to a values of 1 or greater. Higher proportional gain provides a faster response time, but can cause instability.

Integral Gain

This adjustment sets the integration rate of the pressure control loop. The stability cooperates with the Gain setting to provide stable operation. Lowering this value increases the stability.

Derivative

This adjustment compensates the control loop based on the rate of change of the controlled pressure. An increased derivative value will allow a slight increase in the proportional gain (faster response) but excessive values can cause instability.

Gain Switching Threshold	This adjustment sets the width of a window above the minimum and below the maximum range settings. When operating within this “Edge Range”, the Out of Range gain values are used. This allows the 0 % range setting to be set slightly below the valve cracking point, thus ensuring full valve closure. Once the setpoint exceeds the min setting + threshold value, the gains are switched to the “In Control” values. This allows the dynamics to be set for better servo response, while ensuring stability on the seat.
Supply Pressure	This parameter sets a value used within the CPC-II controller to offset the effects of large differential pressures between the supply and control pressure. The default setting is the maximum rating of the unit. Normally this parameter can be left at the default unless the supply pressure is much lower than the rated pressure. For example, if a 25 Bar unit were operated with a supply pressure of 12 Bar, this parameter should be set to 12.
Save Changes	The PID tuning values become active as soon as they are changed using either the up/down arrows or by typing the value. However they are not saved into Non-volatile memory until the Save Changes button is depressed, or the values are saved when exiting the tool. It is important to depress the Save Changes button to ensure that the settings will be retained after a loss of power.
Process PID Settings (At the valve limits or in Slave Mode)	When the valve is operated outside the limits of travel, it is necessary to modify the process PID settings for stable operation. This commonly occurs when the unit is operated at or below the fully seated position.
Manual Control Settings	The pressure setpoint can be input directly from the PC service tool. However, for the manual setpoint or manual potentiometer to control the output pressure, the analog setpoint must be at or below 4 mA. If either analog input is commanding a setpoint higher than 0, the manual setpoint will be ignored.
Mode	To avoid accidental changes in control pressure and servo position, the manual setpoint mode must also be enabled.
Pressure Setpoint	Input the pressure setpoint value or adjust using the up/down arrows.
Manual Potentiometer Stroke Settings	The CPC-II can be operated using the Manual Stroke Adjustment Potentiometer when it is enabled. This function can also be disabled if this feature is not desired for a particular application.
Enable Potentiometer Use	To avoid accidental changes in control pressure and servo position, the manual stroke potentiometer must be enabled. The setting from the manual stroke potentiometer will be ignored whenever the setpoint from either analog input is above 4 mA.
Pressure Setpoint	Input the pressure setpoint value or adjust using the up/down arrows.

5 % Enable
Limit Reached

The manual stroke potentiometer must be set counterclockwise to a value lower than 2 % for at least 10 seconds. The potentiometer will then become active when the potentiometer is set above 5 % for at least 3 seconds. It will remain active as long as the value is above 2 % or until one or more of the analog inputs is greater than 4 mA. The manual stroke mode will expire after 10 seconds if the input is less than 2 %.

2 % Enable
Limit Reached

Silt Buster Settings

The silt buster is a short, symmetrical impulse which moves the valve momentarily in the bypass direction, spilling oil from the control passage to bypass and flushing any silt built up on the control shaft. After the short impulse in the bypass direction, the internal valve is quickly moved above the control point to restore the amount of fluid lost during flush. When properly adjusted, the event happens so quickly that there is no noticeable effect on the position of the controlled actuator. The amount of movement is determined by the Amplitude value. The half duration of the impulse is determined by the pulse duration value. The frequency that the silt buster is triggered is set by the pulse period value.

Amplitude

This value sets the amplitude of the silt-buster impulse. Typically periodic $-/+1$ % impulse is sufficient to flush contaminants from the device. Amplitudes up to $-/+5$ % can be set using the settings editor function of the PC service tool.

Pulse Duration

This adjustment sets the duration of the silt-buster pulse in ms. Typically a duration of 40 ms is sufficient and will not cause undue motion of the servo. The duration can be set from 4 ms to 100 ms. The duration can be modified using the settings editor function of the PC service tool.

Pulse Period

This adjustment sets the interval that the silt-buster impulse will be performed. Typically once per day is sufficient, but durations from 2.4 sec to 30 days can be using the settings editor function of the PC service tool.

Trend Plot

The trend plot displays the time varying values of the setpoint, pressure feedback and internal valve position

Start

To start the trend plot, depress the Start button

Stop

To stop and hold the current display, depress the Stop button

Properties

The properties of the trend plot can be modified by depressing the Properties button. The following properties can be modified:

Update Rate – change the update rate by reducing this value. **Note:** values of less than 50 ms are not effective given the communication rate of the service tool.

Time Scale – the repeat rate of the time scale can be modified by changing this value.

Export

To export the numerical values shown on the trend plot to a comma separated file (.csv) file, depress the Export button. The results can be imported into Microsoft Excel or other math package. The trend plot must be stopped prior to exporting.

Pressure Tracking Diagnostic

Pressure Tracking Threshold

This value sets the threshold of measured error between setpoint and feedback pressure. If this difference persists beyond the limits of the rate parameter, the pressure tracking diagnostic will be enunciated.

Pressure Tracking Rate

This value sets the time window for required convergence between the setpoint and feedback pressure. In the first second, the allowable error is the difference between the setpoint and feedback $\pm 50\%$ of the error. In the second it is the previous error $\pm 25\%$, etc. This allows for short term transient errors and step changes to the setpoint, but sustained errors beyond the threshold value will be enunciated. The time window can be increased to 2 seconds if desired.

Redundancy Overview

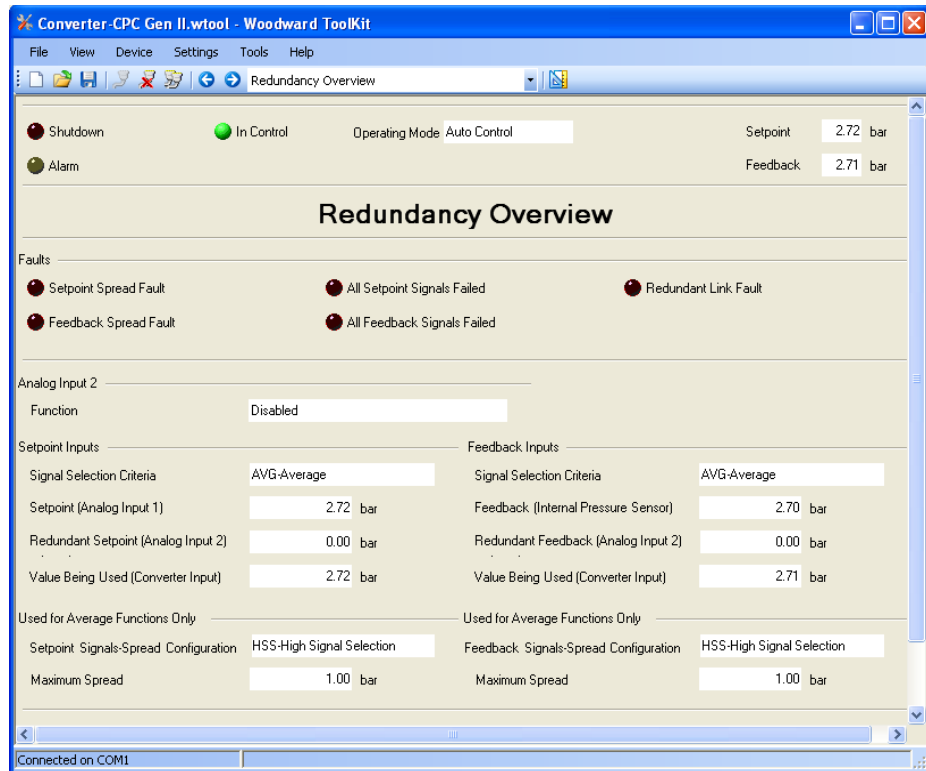

Figure 5-4. Redundancy Overview

Faults	Diagnostics associated with the redundant functions are shown in the faults group.
Setpoint Spread Fault	The difference between the two setpoint signals exceeds the maximum spread threshold. To modify the maximum spread threshold, see configuration in Chapter 6.
Feedback Spread Fault	The difference between the two feedback signals exceeds the maximum spread threshold. To modify the maximum spread threshold, see configuration in Chapter 6.
All Setpoint Signals Failed	Both setpoint signals are outside the allowable range limits. To modify the setpoint range limits, see the analog input configuration in Chapter 6.
All Feedback Signals Failed	Both feedback signals are outside the allowable range limits. To modify the feedback range limits, see the analog input configuration in Chapter 6.
Redundant Link Fault	In a redundant pair arrangement, the pulse train signal normally being received from the 2 nd unit is no longer being detected.
Analog Input 2	When the 2 nd analog input is used for redundant setpoint, the signal conditioning behavior can be selected.
Function	The selected function of the 2 nd analog input is displayed. Disabled – The 2 nd analog input is not being used, and its diagnostics are inactive. Setpoint – The 2 nd input is designated as a redundant setpoint signal and its diagnostics are active. Feedback – The 2 nd input is designated as a redundant feedback signal and its diagnostics are active.
Setpoint Inputs	The values from each setpoint input and the value being used as the operating setpoint are displayed in this group
Signal Selection Criteria	The selected signal selection criteria is displayed. LSS – Low Signal Selection. Using the lower of the two signals HSS – High Signal Selection. Using the higher of the two signals AVG – Average. Using the average of the two signals
Setpoint (Analog Input 1)	The current value of the primary setpoint is displayed in Bar
Redundant Setpoint (Analog Input 2)	The current value of the redundant setpoint is displayed in Bar
Setpoint Used	The current value based on the signal conditioning (i.e. AVG) is displayed. This is the working setpoint of the unit.
Used for Average Functions Only	Displays which signal is used If AVG signal processing is used, and the difference between the two signals exceeds the allowable spread value.

Setpoint Signals Spread Fault Configuration	<p>LSS – Low Signal Selection. Using the lower of the two signals HSS – High Signal Selection. Using the higher of the two signals Disabled – The spread fault will not be annunciated. Failure of a single input will be detected if it falls outside of the Low or High Range limits of the analog input. Note: The effective setpoint will be the average of the two signals.</p>
Maximum Spread	<p>The threshold where the two signals are considered to no longer match. When this value is exceeded, the Spread Fault Behavior determines which signal will be used.</p>
Feedback Inputs	<p>The values from each feedback input and the value being used as the operating feedback level are displayed in this group</p>
Signal Selection Criteria	<p>The selected signal selection criteria is displayed.</p> <p>LSS – Low Signal Selection. Using the lower of the two signals HSS – High Signal Selection. Using the higher of the two signals AVG – Average. Using the average of the two signals</p>
Feedback (Internal Pressure Sensor)	<p>The current value of the internal pressure sensor is displayed in Bar</p>
Redundant Feedback (Analog Input 2)	<p>The current value of the internal pressure sensor is displayed in Bar</p>
Feedback Used	<p>The current value based on the signal conditioning (i.e. AVG) is displayed. This is the working feedback value of the unit.</p>
Used for Average Functions Only	<p>Displays which signal is used If AVG signal processing is selected, and if the difference between the two signals exceeds the allowable spread value.</p>
Feedback Signals Spread Fault Configuration	<p>LSS – Low Signal Selection. Using the lower of the two signals HSS – High Signal Selection. Using the higher of the two signals Disabled – The spread fault will not be annunciated.</p> <p>Failure of a single input will be detected if it falls outside of the Low or High Range limits of the analog input. Note: The effective setpoint will be the average of the two signals.</p>
Maximum Spread	<p>The threshold where the two signals are considered to no longer match. When this value is exceeded, the Spread Fault Behavior determines which signal will be used.</p>

Analog Input Settings

The analog input settings including scaling and diagnostics levels are displayed from this screen. The values of the current operational and diagnostic settings are also displayed. To modify these settings, see section configuration in Chapter 6.

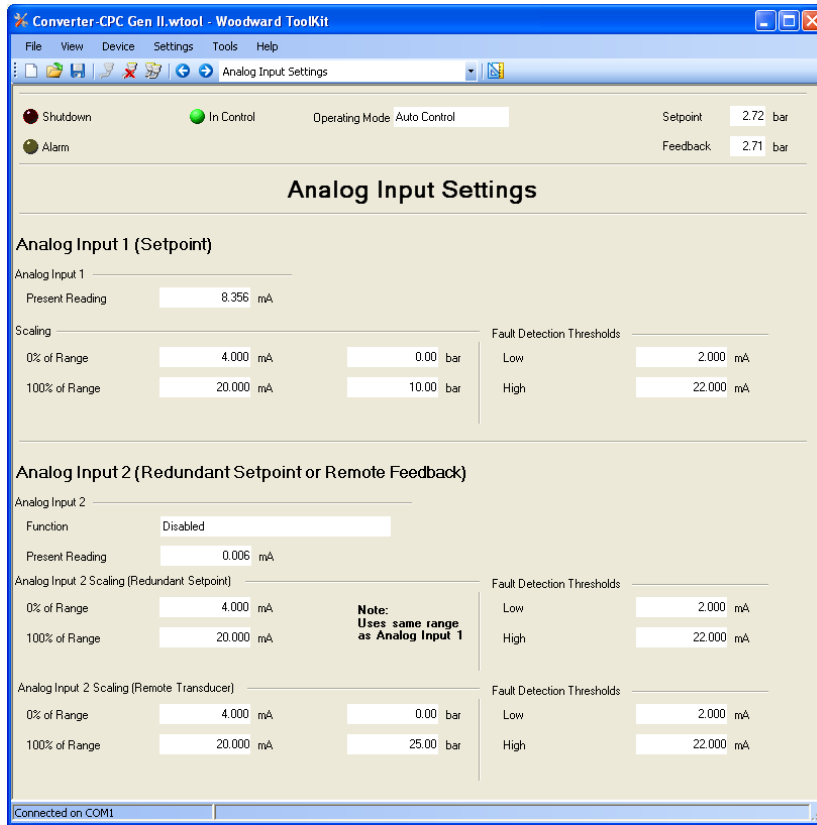

Figure 5-5. PC Service Tool Analog Input Settings

Analog Input 1 and 2

Present Reading	The value at the input of the control is displayed in mA.
0 % of Range Settings	These settings control the minimum level of the control pressure. The 0 % Range pressure setting should be set to a pressure slightly below that required to bring the servo off of the minimum seated position (0.1 to 0.2 Bar) See Figure 5-4. The 0 % range mA setting can also be set to values other than 4 mA to compensate for slight variations in analog output accuracy from the control, or if using the CPC-II in a split range operation with multiple servos. See Chapter 6 on configuration for more details.
100 % of Range Settings	These settings control the maximum control pressure. Typically the 100 % Bar setting corresponds to the pressure required to move the servo to maximum position. See Figure 5-4.
Fault Detection Thresholds	An out of range or invalid input will be enunciated as an alarm or shutdown condition (depending upon configuration) if the input falls below the low limit or above the high limit.

Analog and Discrete Output Settings

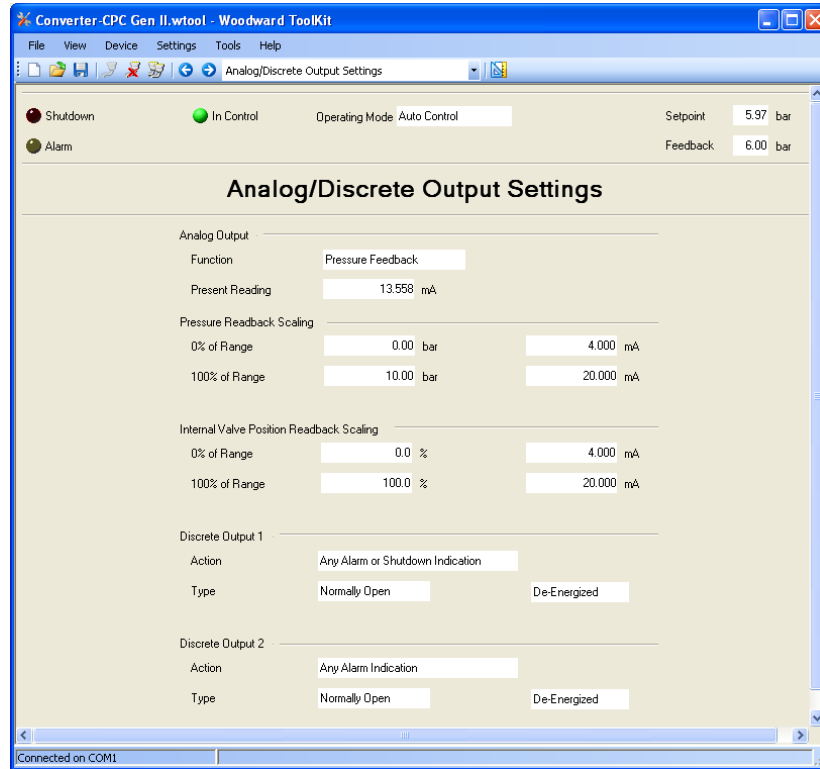

Figure 5-6. PC Service Tool Analog/Discrete Output Settings

Analog Output

Function	The configured function of the analog output is displayed.
Present Reading	The value at the input of the control is displayed in mA.

Pressure Readback Scaling

0 % of Range Settings	This adjustment sets the minimum control pressure corresponding to 4 mA. Typically this scaling is the same as the analog input scaling.
100 % of Range Settings	This adjustment sets the maximum control pressure corresponding to 20 mA. Typically this scaling is the same as the analog input scaling.

Position Readback Scaling

0 % of Range Settings	This adjustment sets the minimum internal valve position corresponding to 4 mA. Typically this is 0 %.
100 % of Range Settings	This adjustment sets the minimum internal valve position corresponding to 20 mA. Typically this is 100 %.

Discrete Output 1 and 2

Discrete Output 1 is fixed to display any alarm or fault condition.

Discrete Output 2 can be configured to enunciate upon detection of the following conditions:

- Action
 - Any Alarm Condition
 - Any Shutdown Condition
 - Any Alarm or Shutdown Condition
 - Operation as Master (redundant configurations)
 - In Control (redundant configurations)

Type Each discrete output can be configured as normally open or normally closed.

Discrete Output 3

Note: Discrete Output 3 is fixed as a pulse train output for use in redundant configurations. It cannot be user configured.

Pressure Demand Linearization Settings

The CPC-II provides a linearization function for actuator/linkage systems with a non-linear relationship of control pressure to position or control pressure to flow rate. This linearization can be used to generate a desired curvature between the input setpoint and the delivered control pressure.

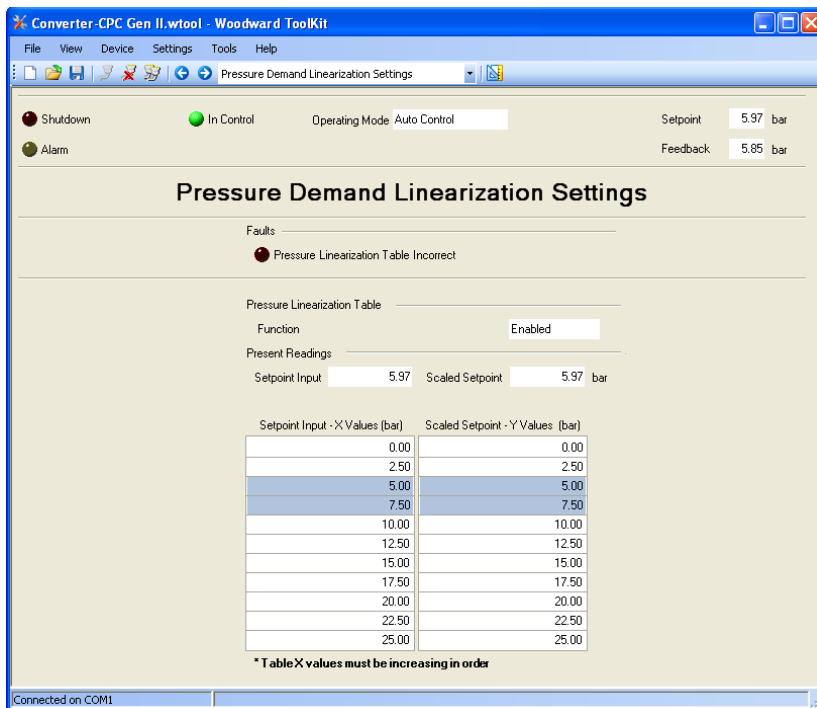

Figure 5-7. PC Service Tool Demand Linearization Settings

Faults

If the Setpoint Input (X-Values) of the table are not ordered in a monotonically increasing fashion a fault will be displayed.

Enabled

The linearization function can be enabled or disabled from the settings editor. When disabled the setpoint is linear with respect to the input.

Linearization Values

Setpoint Input
(x values)

This adjustment sets the minimum control pressure corresponding to 4 mA. Typically this scaling is the same as the analog input scaling.

Setpoint Input
(y values)

This adjustment sets the maximum control pressure corresponding to 20 mA. Typically this scaling is the same as the analog input scaling.

Detailed Diagnostics

The current state of the CPC-II's internal diagnostics are displayed on this page. In addition, the value of a few key parameters which can be used for troubleshooting are also displayed. Resetting of all active and logged faults is performed from this page.

Each diagnostic is also enunciated as a numerical flash code by the LED on the PCB. This flash code consists of two values, the first is the group number as described below followed by a one second delay, the second is the specific diagnostic which has been detected. A three-second pause separates multiple diagnostic flash code messages.

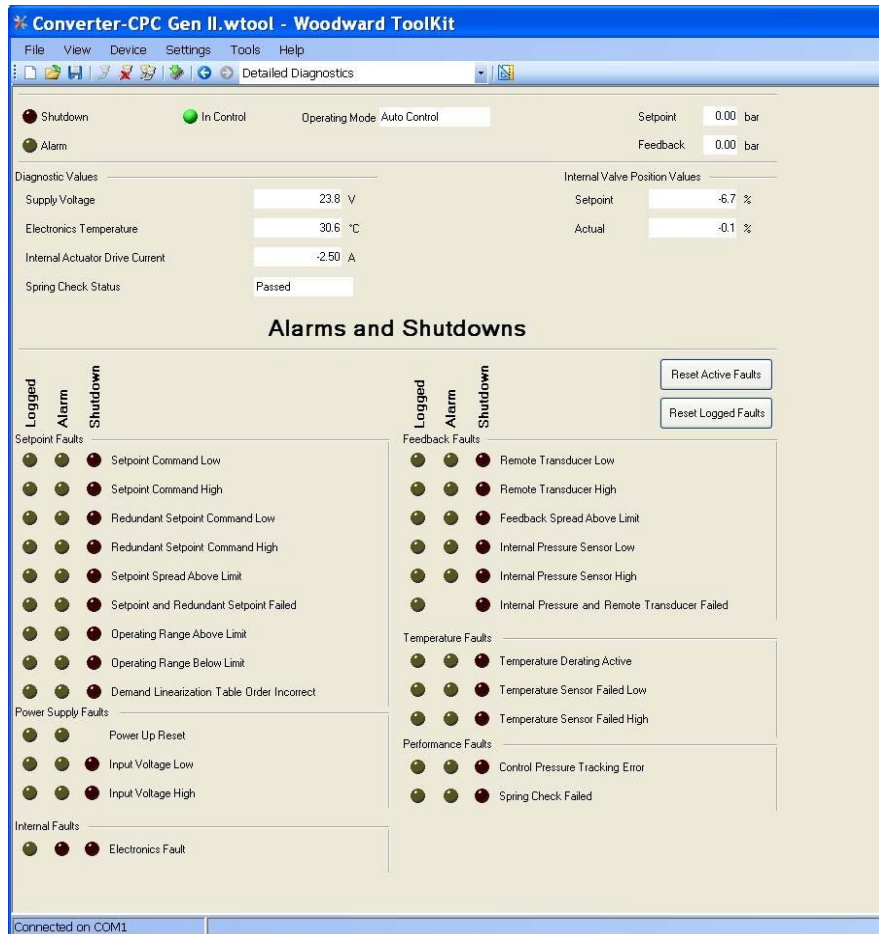

Figure 5-8. PC Service Tool Detailed Diagnostics Screen

Diagnostic Values	This list of parameters is provided for determination of external or performance factors, which may be related to performance or enunciated diagnostics.
Supply Voltage	The current voltage as measured at the power supply input is displayed.
Electronics Temperature	The temperature in degrees C is displayed.
Internal Actuator Drive Current	The drive current required to operate the actuator is displayed. Note: This signal is typically a very active signal.
Spring Check Status	When enabled, the status of the spring check function performed during power up is displayed. The spring check can be enabled or disabled by configuring this diagnostic. See Chapter 6.
Internal Valve Position Values	The values for the internal valve position setpoint and actual position are displayed in the upper right, below the header
Setpoint	The setpoint for the position of the internal valve, computed by the CPC-II's control algorithm as necessary for pressure control. 0 is full bypass, 100 % is full supply. Normal control is approximately 50 %.
Actual	The actual position of the internal valve in %.
Logged Faults	Any diagnostic that has occurred since the last Logged Fault Reset will be recorded in the Logged Fault column.
Alarm	A condition has been detected which is outside of normal operating limits, but which does not impede the overall operation of the device. The indicated diagnostic condition currently exists or has occurred in the past and the diagnostic is configured as latching. If the condition no longer exists, depressing the Reset Active Faults button will clear the enunciation. A persistent diagnostic that does not clear after depressing the Reset Active Faults button indicates that the detected condition still exists.
Shutdown	A condition has been detected which is outside of safe operating limits and which requires shutdown of the device. The indicated diagnostic condition currently exists or has occurred in the past and the diagnostic is configured as latching. If the condition no longer exists, depressing the Reset Active Faults button can clear the enunciation. A persistent diagnostic that does not clear after depressing the Reset Active Faults button indicates that the detected condition still exists.

LED Flash Codes

The status LED inside the unit will flash all detected diagnostics conditions, which represent a two numeral code. The code consists of a sequence of flashes followed by a 1 second pause. A 2nd flash sequence follows with a 3 second pause. The first numeral represents the fault group. The second numeral represents the specific fault within this group. For example a flash code of : **** _ ** _ _ _ represents Fault Group 4, Fault 3 or Feedback Spread Above Limit. The fault group and code are listed for all displayed faults below.

Setpoint Faults

This group lists the various diagnostics which monitor the setpoint signal(s). Typically these faults are a result of wiring problems or scaling problems at the controller or within the CPC-II settings. These conditions do not indicate a fault within the device. The limits used to detect these diagnostics can be modified using the settings editor. See Chapter 6 on configuring the CPC-II.

Flashcode Group 1

	Flash Code	
Setpoint Command Low	1	The analog input value for the primary setpoint is below the low diagnostic threshold. Verify that the input is active and connected properly.
Setpoint Command High	2	The analog input value for the primary setpoint is above the high diagnostic threshold. Verify that the input is active and connected properly.
Redundant Setpoint Command Low	3	The analog input value for the redundant setpoint is below the low diagnostic threshold. Note , the function of the 2 nd analog input must be set to Setpoint to enable this diagnostic. Verify that the input is active and connected properly. Disable the 2 nd analog input function if it is not used.
Redundant Setpoint Command High	4	The analog input value for the primary setpoint is above the high diagnostic threshold. Note , the function of the 2 nd analog input must be set to Setpoint to enable this diagnostic. Verify that the input is active and connected properly. Disable the 2 nd analog input function if it is not used.
Setpoint Spread Above Limit	5	The difference between the two analog inputs exceeds the spread setting. Note that the AVG mode must be set to enable this diagnostic.
Setpoint and Redundant Setpoint Failed	6	The analog input value for the both the setpoint and redundant setpoint are outside the diagnostic threshold settings.
Operating Range Above Limit	7	The range limit settings exceed the upper range limit of the device. Note : the ratings are dependent upon the part number of the CPC-II. Correct the input range settings, See Chapter 6 on configuring the CPC-II.
Operating Range Below Limit	8	The range limit settings exceed the lower range limit of the device. Note : the ratings are dependent upon the part number of the CPC-II. Correct the input range settings, See Chapter 6 on configuring the CPC-II.

Demand Linearization Table Order Incorrect	9	The numerical order of the x value entries in the Demand Linearization table is not monotonically increasing. Correct the values entered in the table. See Chapter 6 on configuring the CPC-II.
Power Supply Faults Flashcode Group 2		This group lists the various diagnostics which monitor the input power to the device. Typically these faults are a result of the power source, fusing or wiring to the unit. These conditions generally do not indicate a fault within the device.
	Flash Code	
Power Up Reset	1	This diagnostic detects a loss of input power since the last reset.
Input Voltage Low	2	The input voltage is below the low diagnostics threshold
Input Voltage High	3	The input voltage is above the high diagnostics threshold
Internal Faults Flashcode Group 3		This diagnostic is a summary of several internal operational checks performed by the CPC-II.
	Flash Code	
Electronics Fault	1	Typically these faults are a result of a problem within the unit. Contact Woodward for further instructions if this diagnostic is active.
Feedback Faults Flashcode Group 4		This group includes diagnostics which monitor the pressure feedback sensor(s). These faults are generally related to performance or calibration of the pressure feedback device.
	Flash Code	
Remote Transducer Low	1	The analog input value for the remote transducer is below the low diagnostic threshold. Verify that the input is active and connected properly. Note: the function of the 2 nd analog input must be set to Feedback to enable this diagnostic. Verify that the input is active and connected properly. Disable the 2 nd analog input function if it is not used.
Remote Transducer High	2	The analog input value for the remote transducer is above the high diagnostic threshold. Verify that the input is active and connected properly. Note: the function of the 2 nd analog input must be set to Feedback to enable this diagnostic. Verify that the input is active and connected properly. Disable the 2 nd analog input function if it is not used.
Feedback Spread Above Limit	3	The difference between the two analog inputs exceeds the spread setting. Note that the AVG mode must be set to enable this diagnostic.
Internal Pressure Sensor Low	4	The analog input value from the internal pressure sensor is below the low diagnostic threshold. Verify that the internal sensor is connected properly or replace the internal sensor.
Internal Pressure Sensor High	5	The analog input value from the internal pressure sensor is above the high diagnostic threshold. Verify that the internal sensor is connected properly or replace the internal sensor.

Internal Pressure and Remote Transducer Failed	6	The analog input value for the both the internal and remote transducer are outside the diagnostic threshold settings. Verify the wiring of both internal and external sensors. Note: the function of the 2 nd analog input must be set to Feedback to enable the 2 nd analog input for redundant feedback operation.
Temperature Faults Flashcode Group 5		This diagnostic group lists various diagnostics which indicate if the device is operating outside of the recommended thermal operating limits.
	Flash Code	
Temperature Derating Active	1	The internal temperature is above the derating threshold. The available drive current to the internal valve will be reduced.
Electronics Temperature Low	2	The internal temperature is below the rated operating temperature. Increase the temperature by enclosing the unit or providing warm oil to the supply.
Electronics Temperature Low	3	The internal temperature is above the rated operating temperature. Decrease the temperature by cooling the oil supply or reducing the ambient temperature.
Performance Faults Flashcode Group 6		This diagnostic displays faults related to the ability to control pressure, and the self test function of the return spring. Contact Woodward for further instructions if this diagnostic is active.
	Flash Code	
Control Pressure Tracking Error	1	The CPC-II is not able to control the pressure to match the setpoint within the Tracking Fault settings. Ensure that the supply pressure and flow rate are adequate for full transient operation. The Tracking Fault settings can be modified in special cases.
Spring Check Failed	2	The return spring can be configured to perform a self check upon power up. This diagnostic indicates that the spring check has failed. Verify that the oil meets the necessary cleanliness. Inspect the return spring. Note the precautionary warnings on the lower label.
Redundancy Faults Flashcode Group 7		This diagnostic is a summary of diagnostics performed on the status link when two units are used in a redundant configuration. Typically these faults result if the redundant link is lost between units or if the Master/Slave designation by the main controller is inconsistent with the health monitoring status between units. Contact Woodward for further instructions if this diagnostic is active.
	Flash Code	
Redundant Link Input Failure	1	For redundant units only. The pulse train from the other CPC-II cannot be detected. Check the redundant link wiring between the two CPC-II's. Check the configuration of the unit on the Redundancy Overview screen. The unit must be factory configured as a redundant unit and the function must be set for Redundant operation.
Forced to Yield Control Error	2	For redundant units only. The unit designated as the Master has yielded control to the other unit. Check the redundant link wiring between the two CPC-II's.

Chapter 6.

Configuring the CPC-II Using the PC Service Tool

Introduction

After installation, certain settings in the CPC-II must be set for proper operation using the PC Service Tool. The following section includes information for proper verification of settings. The settings described in this section can be modified using the settings editor, an off-line configuration tool. These settings do not become active until the settings are uploaded into the control. These settings can be saved and uploaded into multiple controls by saving a copy and uploading the saved version into the control.

WARNING

The engine, turbine, or other type of prime mover should be equipped with an overspeed shutdown system to protect against runaway or damage to the prime mover with possible personal injury, loss of life, or property damage.

The overspeed shutdown system must be totally independent of the prime mover control system. An overtemperature or overpressure shutdown system may also be needed for safety, as appropriate.

The prime mover must be shut down and in a safe operating condition prior to making modifications to the CPC-II configuration.

To access the settings editor, it is first necessary to create a settings file from the device. To create a new settings file, go to the settings pull down menu and select Save from Device to File and save to an appropriate folder on your computer. **Note:** it is good practice to make a back-up file which can be used to restore the original settings should a problem occur with new settings.

After creating the back-up file, create another file by repeating the process above. Store this file as a different file name from the back-up file.

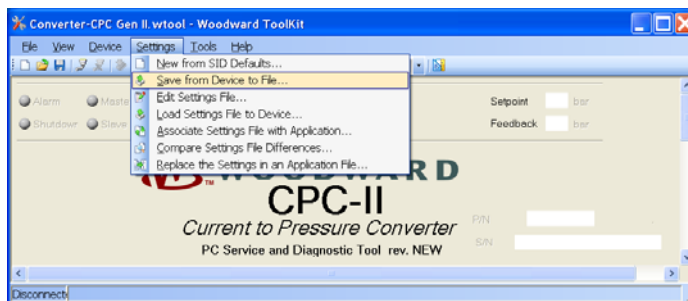

Figure 6-1. Accessing the Settings File

To make changes to the configuration, select Edit Settings file from the pull down menu. This will launch the settings editor, a set of screens which allows off-line changes to settings in the control.

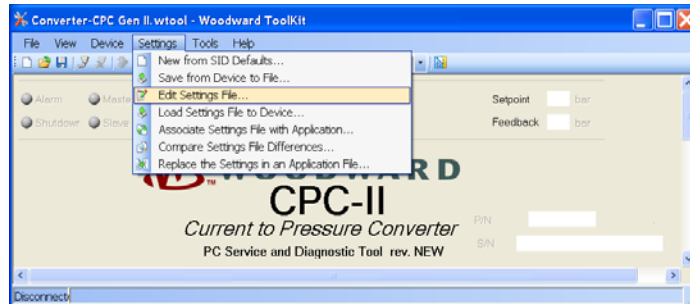

Figure 6-2. Loading the Settings File to the Device

Once the desired changes have been made, upload them into the control by selecting the Load Settings File to Device option from the pull down menu.

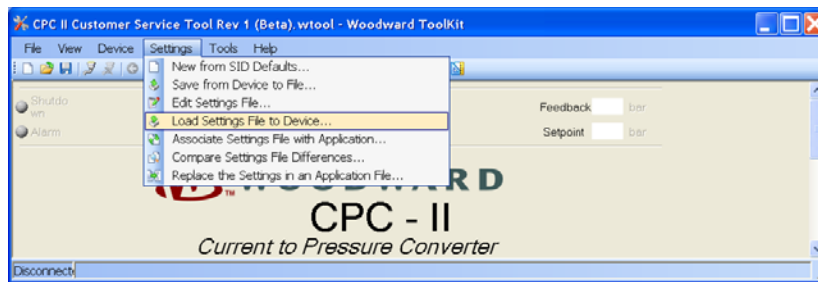

Figure 6-3. Loading the Settings File to the Device

Dynamic Performance Settings

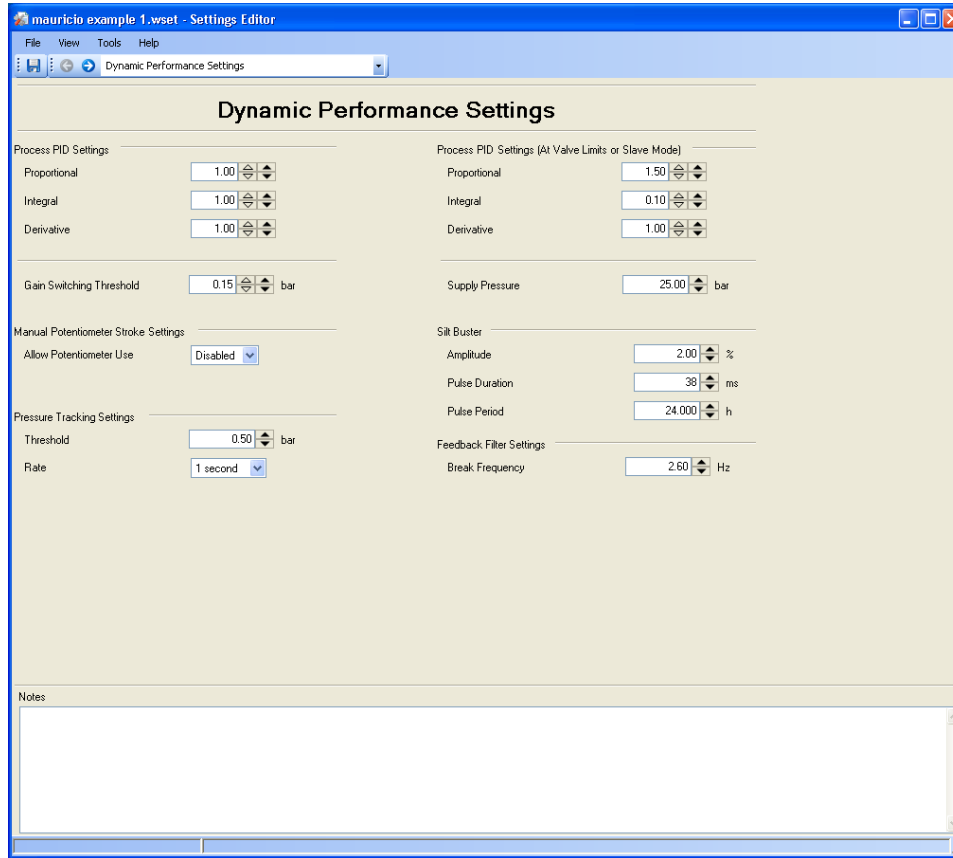

Figure 6-4. Dynamic Performance Configuration Page

Process PID Settings

This group contains the settings used to tune the CPC-II for stability and appropriate dynamic performance.

Proportional Gain

This adjustment sets the amount of proportional action for the pressure control loop. In most cases, the values can be set to a values of 1 or greater. Higher proportional gain provides a faster response time, but can cause instability.

Integral Gain

This adjustment sets the integration rate of the pressure control loop. Increasing the integral gain reduces the time required to reach the setpoint. Reducing this value will result in slower response but increases stability. Excessive integral gain can result in high overshoot or slow oscillation around the setpoint.

Derivative

This adjustment compensates the control loop based on the rate of change of the controlled pressure. An increased derivative value will allow a slight increase in the proportional gain (faster response) but excessive values can cause instability.

Gain Switching Threshold

This adjustment sets the width of a window above the minimum and below the maximum range settings. When operating within this “Edge Range”, the Out of Range gain values are used. This allows the 0 % range setting to be set slightly below the valve cracking point, thus ensuring full valve closure. Once the setpoint exceeds the min setting + threshold value, the gains are switched to the “In Control” values. This allows the dynamics to be set for better servo response, while ensuring stability on the seat.

Supply Pressure	<p>This parameter sets a value used within the CPC-II controller to offset the effects of large differential pressures between the supply and control pressure. The default setting is the maximum rating of the unit. Normally this parameter can be left at the default unless the supply pressure is much lower than the rated pressure. For example, if a 25 Bar unit were operated with a supply pressure of 12 Bar, this parameter should be set to 12.</p>
Process PID Settings (At the valve limits or in Slave Mode)	<p>When the valve is operated at or beyond its travel limits (i.e. fully seated position and maximum travel), it is necessary to reduce the process PID settings for stable operation. Typically values of 1 will produce stable operation when beyond the normal operating range.</p>
Manual Control Settings	<p>The pressure setpoint can be input directly from the PC service tool. However, for the manual setpoint or manual potentiometer to control the output pressure, the analog setpoint must be at or below 4 mA. If either analog input is commanding a setpoint higher than 0, the manual setpoint will be ignored.</p>
Mode	<p>To avoid accidental changes in control pressure and servo position, the manual setpoint mode must be enabled prior to use of the manual setpoint adjustment. To always allow the use of the manual setpoint adjustment from the monitoring screen select Enable from the pull down menu. To set the default behavior to ignore the manual setpoint, select Disable.</p>
Pressure Tracking Diagnostic	
Threshold	<p>This value sets the threshold of measured error between setpoint and feedback pressure. If this difference persists beyond the limits of the rate parameter, the pressure tracking diagnostic will be enunciated.</p>
Rate	<p>This value sets the time window for required convergence between the setpoint and feedback pressure. In the first second, the allowable error is the difference between the setpoint and feedback $\pm 50\%$ of the error. In the second it is the previous error $\pm 25\%$, etc. This allows for short term transient errors and step changes to the setpoint, but sustained errors beyond the threshold value will be enunciated. The time window can be increased to 2 seconds if desired.</p>
Silt Buster Settings	
Amplitude	<p>This parameter sets the amplitude of the silt-buster impulse. Typically periodic $-/+ 1\%$ impulse is sufficient to flush contaminants from the device. Amplitudes up to $-/+5\%$ can be set.</p>
Pulse Duration	<p>This parameter sets the duration of the silt-buster pulse in ms. Typically a duration of 40 ms is sufficient and will not cause undue motion of the servo. The duration can be set from 4 ms to 100 ms.</p>
Pulse Period	<p>This parameter sets the interval that the silt-buster impulse will be performed. Typically once per day is sufficient, but durations from 2.4 sec to 30 days can be set.</p>
Feedback Filter Settings	
Time Constant	<p>Adjusting the feedback filter time constant decreases the damping of the feedback value displayed on the screen and the analog output. This filter can be disabled by inputting a value of 0.</p>

Configure Redundancy

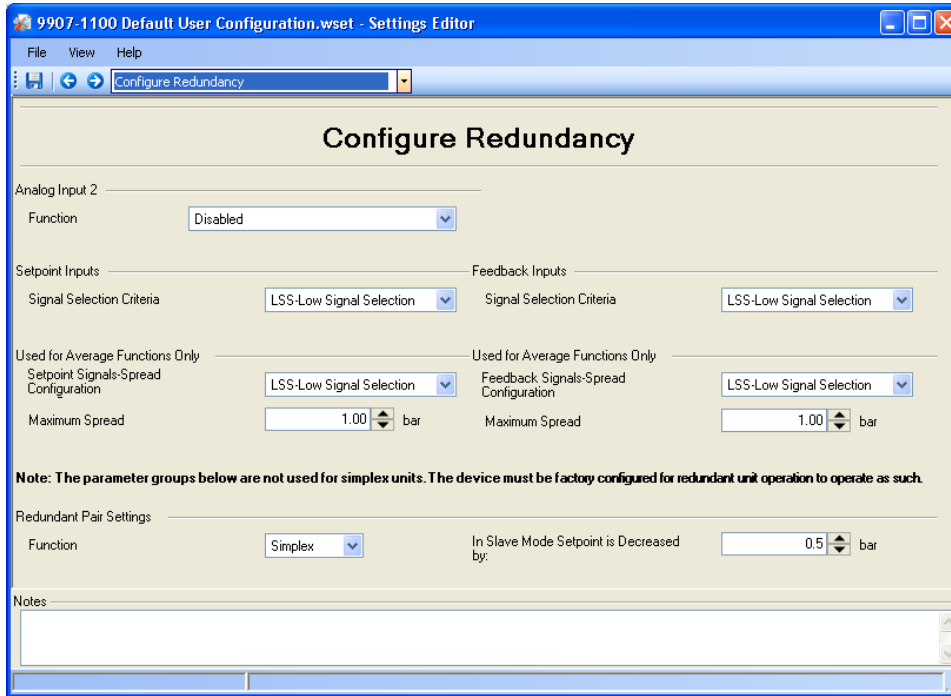

Figure 6-5. Redundancy Configuration Page

Analog Input 2

The second analog input can be used for redundant setpoint or redundant feedback signals.

Choose the desired function from the pull-down window.

Function	Disabled – Not used. Also diagnostics on Input 2 are disabled. Redundant Setpoint Redundant Feedback – * From an external transmitter.
----------	--

Setpoint Inputs

When the 2nd analog input is used for redundant setpoint, the signal conditioning behavior can be selected.

Choose the desired signal selection criteria from the pull-down window.

Signal Selection Criteria	LSS – Low Signal Selection. Will use the lower of the two signals HSS – High Signal Selection. Will use the higher of the two signals AVG – Average. Will use the average of the two signals
---------------------------	--

Used for Average Functions Only

If AVG signal processing is used, and the difference between the two signals exceeds the allowable spread value, the choice of which signal should be used can be selected from the pull-down menu.

Choose the desired signal if the setpoint value exceeds the spread limit.

Setpoint Signal
Spread Fault Behavior

LSS – Low Signal Selection. Use the lower of the two signals
HSS – High Signal Selection. Use the higher of the two signals
Disabled – The spread fault will not be annunciated. Failure of a single input will be detected if it falls outside of the Low or High Range limits of the analog input. **Note:** The effective setpoint will be the average of the two signals.

Maximum Spread

This parameter sets the threshold where the two signals are considered to no longer match. When this value is exceeded, the Spread Fault Behavior determines which signal will be used.

Feedback Inputs

When the 2nd analog input is used for redundant feedback, the signal conditioning behavior can be selected.

Choose the desired signal selection criteria from the pull-down window.

Signal Selection
Criteria

LSS – Low Signal Selection. Will use the lower of the two signals
HSS – High Signal Selection. Will use the higher of the two signals
AVG – Average. Will use the average of the two signals

Used for Average Functions Only

If AVG signal processing is used, and the difference between the two signals exceeds the allowable spread value, the choice of which signal should be used can be selected from the pull-down menu.

Choose the desired signal if the setpoint value exceeds the spread limit.

Feedback Signal
Spread Fault Behavior

LSS – Low Signal Selection. Use the lower of the two signals
HSS – High Signal Selection. Use the higher of the two signals
Disabled – The spread fault will not be annunciated. Failure of a single input will be detected if it falls outside of the Low or High Range limits of the analog input. **Note:** The effective setpoint will be the average of the two signals.

Maximum Spread

This parameter sets the threshold where the two signals are considered to no longer match. When this value is exceeded, the Spread Fault Behavior determines which signal will be used.

Redundant Pair Settings

When two valves are used in a redundant pair, a unit configured for redundant operation must be used. The redundant unit supports both redundant and simplex functions. When using redundant units, the setpoint of the 2nd CPC-II is reduced when in slave mode so that the two units do not interact. The amount of pressure reduction is tunable.

Choose the desired operation for the unit.

Function Redundant or Simplex – The unit supports both simplex and redundant functions

Simplex – The unit supports only simplex functions. Monitoring of the redundant link, and automatic crossover functions are not supported in this mode.

In Slave Mode
Setpoint is Decreased
by

In a redundant arrangement, the amount of setpoint reduction (in Bar) for the slave unit, is set using this parameter.

IMPORTANT	<p>For proper operation of redundant CPC-II's, it is important that the manifold block, switching valves and other key components be properly sized and capable of the necessary dynamic performance.</p> <p>Please contact Woodward for further information and engineering recommendations on redundant systems prior to designing or operating the CPC-II in a redundant pair arrangement.</p>
------------------	---

Analog Input Settings

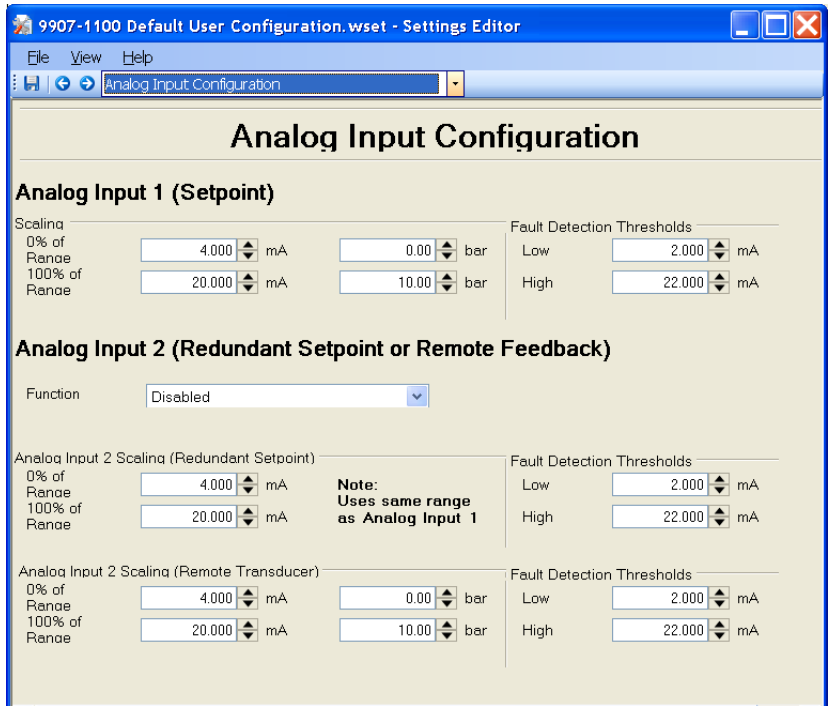

Figure 6-6. Analog Input Settings Page

Analog Input 1 and 2

0 % of Range	These settings control the minimum level of control pressure. The pressure setting value should correspond to a pressure just slightly below that required to reach the minimum travel of the servo. See Figure 6-7. The 0 % range can be set to values other than 4 mA to compensate for slight variations in control accuracy from the control, or for split range operation of multiple servos. See configuration.
100 % of Range	This adjustment sets the maximum control pressure. Typically this setting corresponds to the pressure required to move the servo to maximum position. See Figure 6-7.
Function	The 2 nd analog input can be configured for use as a redundant feedback signal or a redundant transducer. Select the desired use by selecting from the pull down menu.
Fault Detection Thresholds	An out of range or invalid input will be enunciated as an alarm or shutdown condition (depending upon configuration) if the input falls below the low limit or above the high limit.

The CPC-II allows the setpoint range to be set slightly wider than the physical stroke pressure range of the servo. This enables the valve to be firmly seated in the fully closed position. Since operating below the servo range increases the system “hydraulic stiffness” as seen by the CPC-II, it may be necessary to adjust the gain switching threshold for optimum system response. This allows for more responsive PID settings in the normal control range, while maintaining stable operation when the valve is seated. For optimum performance, set the 0 % range pressure to a value approximately 2.5 % below the pressure required to move the valve off of the minimum stop. Set the gain switching threshold at 2.5 % of the maximum servo pressure. The gain switching threshold can be adjusted to be greater or narrower depending upon the application.



To prevent personal injury or death and damage to equipment, the servo must be closed completely when the control pressure is at the minimum level.

Verify that the servo is fully closed when the control pressure is at 4 mA and that the minimum machine speed can be controlled at this level. Refer to the start up instructions for the prime mover for recommended start-up and verification procedures.

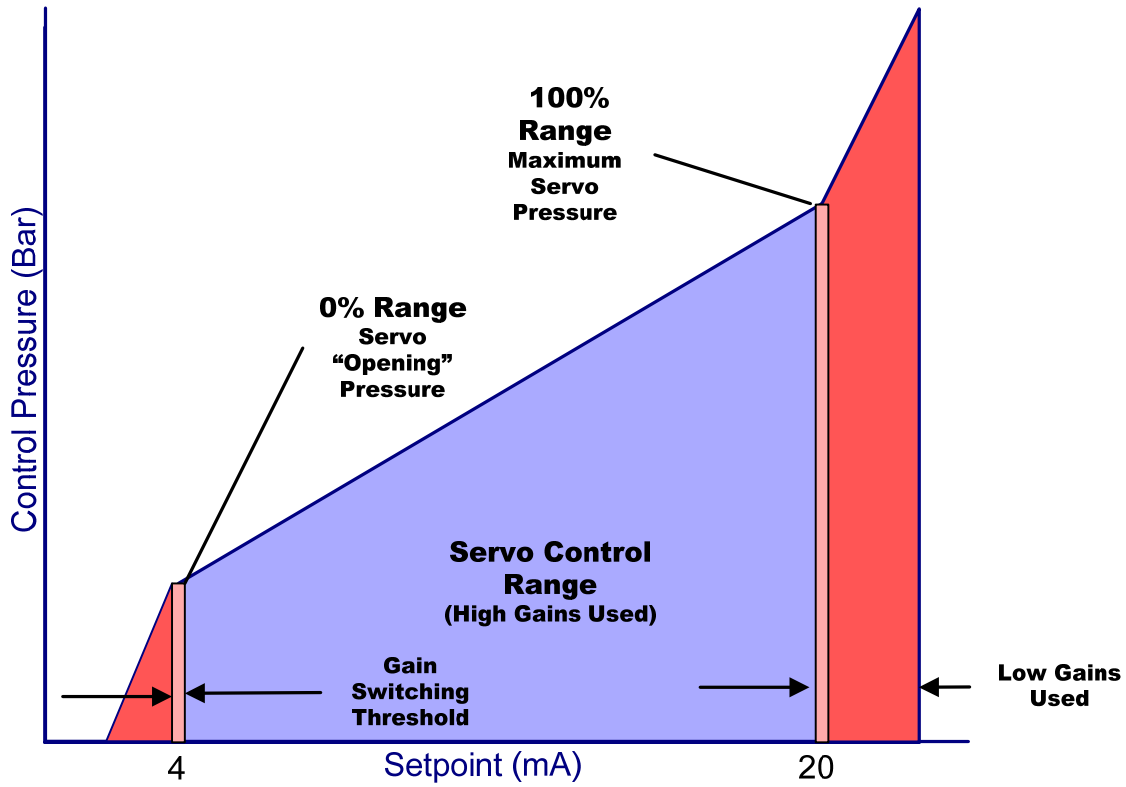

Figure 6-7. Analog Input Setpoint Scaling

Analog and Discrete Output Settings

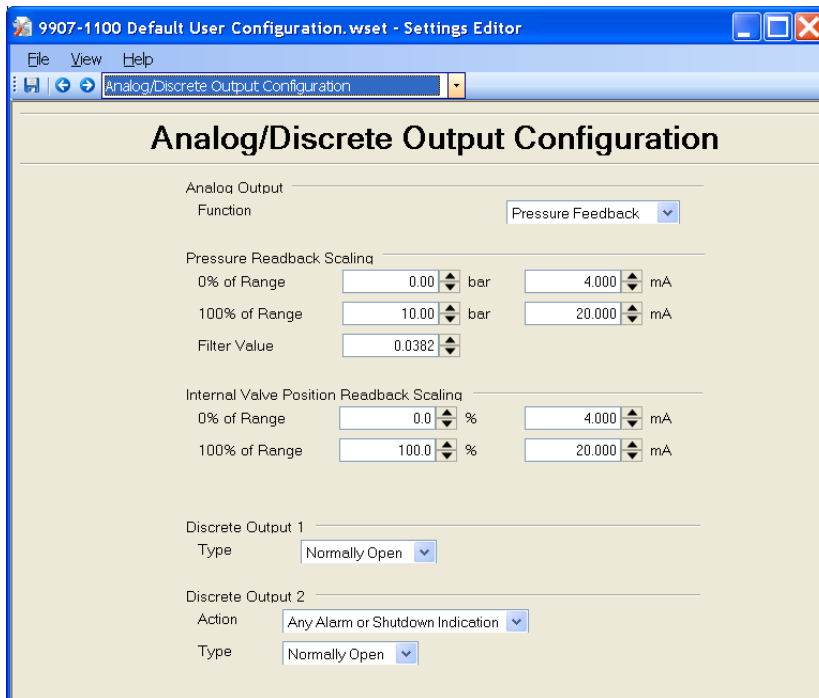

Figure 6-8. PC Service Tool Analog/Discrete Output Settings

Analog Output

Function

The analog output can be configured to output the following parameters:
 Pressure Setpoint
 Pressure Feedback
 Internal Valve Position Feedback

Pressure Readback Scaling

0 % of Range

This adjustment sets the minimum control pressure corresponding to 4 mA. Typically this scaling is the same as the analog input scaling.

100 % of Range

This adjustment sets the maximum control pressure corresponding to 20 mA. Typically this scaling is the same as the analog input scaling.

Feedback Filter Time Constant

Note: The settings for the feedback filter time constant can be modified from the Dynamic Performance Settings screen. This filter smoothes the analog output signal as well as the trend plot.

Position Readback Scaling

0 % of Range Settings

This adjustment sets the minimum internal valve position corresponding to 4 mA. Typically this is 0 %.

100 % of Range Settings

This adjustment sets the maximum internal valve position corresponding to 20 mA. Typically this is 100 %.

Discrete Output 1 and 2

Action

Discrete Output 1 is fixed to display any alarm or fault condition.

Discrete Output 2 can be configured to enunciate upon detection of the following conditions:

Any Alarm Condition
 Any Shutdown Condition
 Any Alarm or Shutdown condition
 Operation as Master (redundant configurations)
 In Control (redundant configurations)

Type

Each discrete output can be configured as normally open or normally closed.

Discrete Output 3

Note: Discrete Output 3 is fixed as a pulse train output for use in redundant configurations. It cannot be user configured.

Pressure Demand Linearization Settings

The parameters of the Pressure Demand Linearization table can be adjusted to compensate for non-linear linkage or spring characteristics in the servo system.

Enabled

The linearization function can be enabled or disabled from the settings editor. When disabled the setpoint is linear with respect to the input.

Linearization Values

Setpoint Input
(X values)

The values in the left column represent the unscaled input values in Bar. The values in this column must increase progressively. For example: the value in row 5 cannot be lower than the value in row 6.

Scaled Setpoint
(Y values)

The values in the right column represent the scaled input values in Bar. The values in this column do not need to be progressively increasing.

Example: A servo requires a nominal value of 2 Bar to move from the seated position, and 12 Bar to reach full travel. To reach 10 % of travel, 3 Bar is required, at 20 % travel 4 Bar is required, at 30 % travel 4.5 Bar is required, at 40 % travel 5 Bar is required. At 50 % travel, 5.8 Bar is required. At 60 % travel, 6.8 Bar is required. The remainder of the travel is linear. The Linearization Table would be input as follows:

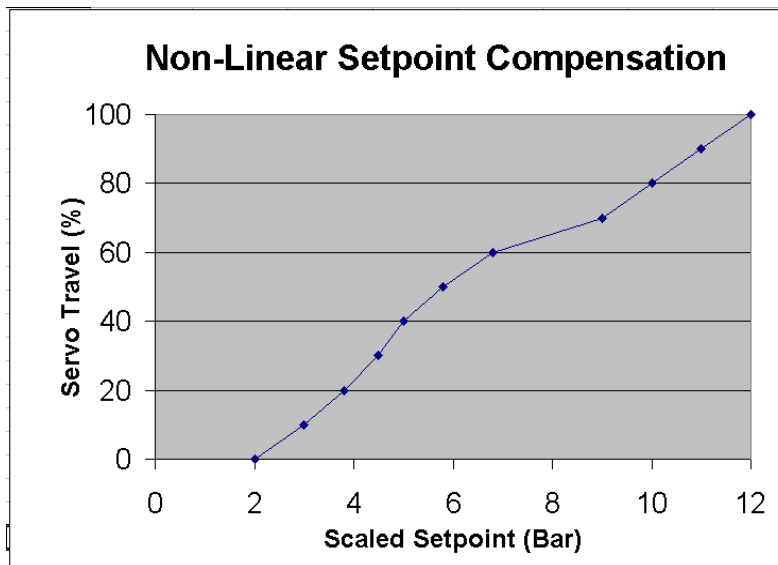

Figure 6-9. PC Service Tool Demand Linearization Configuration

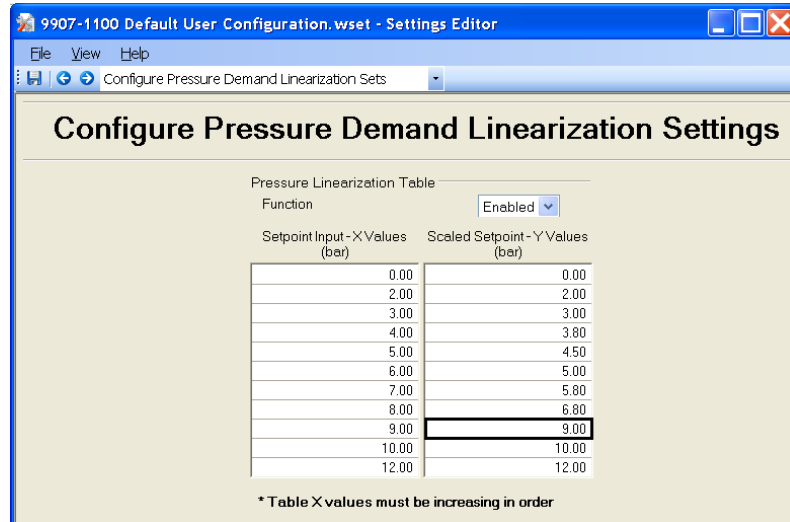

Figure 6-10. PC Service Tool Demand Linearization Configuration

Detailed Diagnostics Configuration

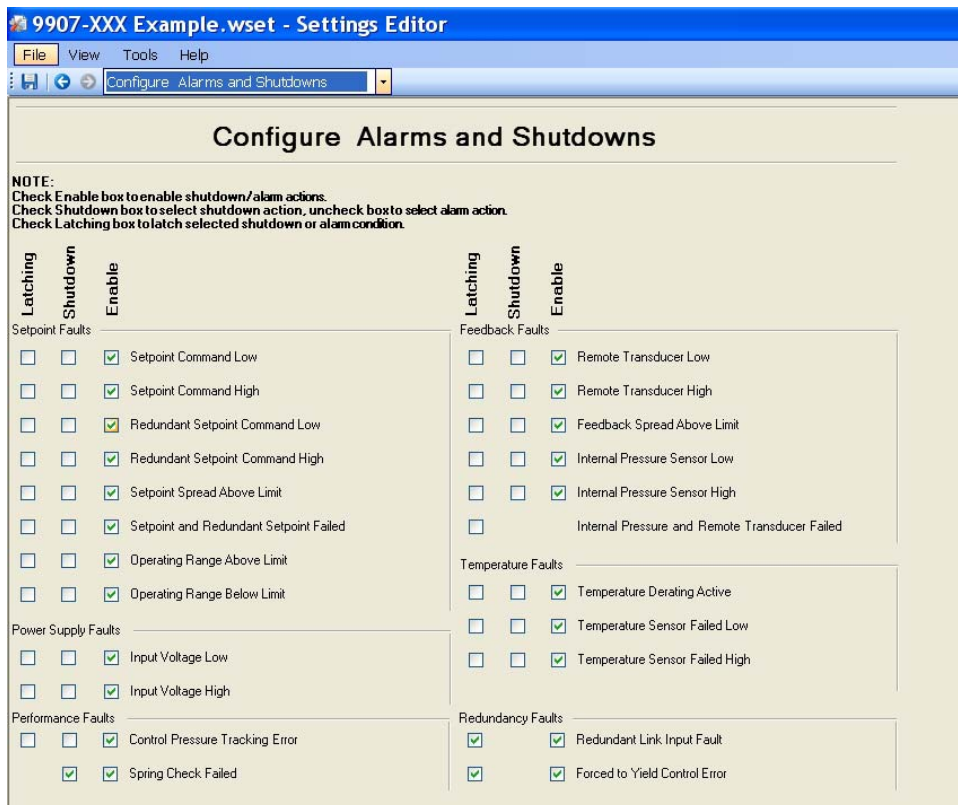

Figure 6-11. PC Service Tool Diagnostics Settings Editor

Latching Faults

A latching fault will hold the designated behavior including the status of the discrete output until the fault is reset from the PC service tool. A unlatching fault will clear the diagnostic condition including the state of the discrete output as soon as the condition resulting in the diagnostic enunciation no longer exists.

**WARNING**

Configuring some diagnostics as a non-latching shutdown can result in unexpected behavior. In some cases the diagnostic condition may disappear while the unit is in the process of shutting down, allowing the system to resume operation. This can result in wide pressure and speed fluctuations. It is highly recommended that the control system latch any shutdown it detects via the discrete output to prevent unexpected behavior.

Shutdown If the box in the Shutdown column is checked, the detection of this diagnostic condition will result in shutdown of the CPC-II. If it is unchecked, the detection will result in enunciation of the condition on the alarm contact.

Enable If the box in the Enable column is checked, this diagnostic will be active and its behavior will be as set by the Shutdown setting. If it is unchecked, this diagnostic will be ignored.

Setpoint Faults

This group lists the various diagnostics which monitor the setpoint signal(s). Typically these faults are a result of wiring problems or scaling problems at the controller or within the CPC-II settings. These conditions do not indicate a fault within the device.

Setpoint Command Low The analog input value for the primary setpoint is below the low diagnostic threshold. This is usually best corrected by ensuring that the control system is providing a valid signal between 4 mA and 20 mA.

Setpoint Command High The analog input value for the primary setpoint is above the high diagnostic threshold. This is usually best corrected by ensuring that the control system is providing a valid signal between 4 mA and 20 mA.

Redundant Setpoint Command Low The analog input value for the redundant setpoint is below the low diagnostic threshold. **Note:** the function of the 2nd analog input must be set to Setpoint to enable this diagnostic. Verify that the input is active and connected properly. Disable the 2nd analog input function if it is not used.

Redundant Setpoint Command High The analog input value for the redundant setpoint is above the high diagnostic threshold. **Note:** the function of the 2nd analog input must be set to Setpoint to enable this diagnostic. Verify that the input is active and connected properly. Disable the 2nd analog input function if it is not used.

Setpoint Spread Above Limit The difference between the two analog inputs exceeds the spread setting. Note that the AVG mode must be set and spread must be enabled for performance of this diagnostic.

Setpoint and Redundant Setpoint Failed	The analog input value for the both the setpoint and redundant setpoint are outside the diagnostic threshold settings. It is generally not recommended that this diagnostic be disabled or configured for alarm only as the unit is running without a valid input. This is usually best corrected by ensuring that the control system is providing a valid signal between 4 mA and 20 mA to either or both the setpoint and redundant setpoint inputs.
Operating Range Above Limit	The range limit settings exceed the upper range limit of the device. Note: this is determined by the part number and ratings of the CPC-II. Correct the input range settings,
Operating Range Below Limit	The range limit settings exceed the lower range limit of the device. Note: this is set by the part number and ratings of the CPC-II. Correct the input range settings.
Power Supply Faults	This group lists the various diagnostics which monitor the input power to the device. Typically these faults are a result of the power source, fusing or wiring to the unit. These conditions generally do not indicate a fault within the device.
Input Voltage Low	The input voltage is below the low diagnostics threshold
Input Voltage High	The input voltage is above the high diagnostics threshold
Redundancy Faults	This diagnostic is a summary of diagnostics performed on the status link when two units are used in a redundant configuration. Typically these faults result if the redundant link is lost between units or if the Master/Slave designation by the main controller is inconsistent with the health monitoring status between units. Contact Woodward for further instructions if this diagnostic is active.
Redundant Link Input Failure	For redundant units only. The pulse train from the other CPC-II cannot be detected. Check the redundant link wiring between the two CPC-II's. Check the configuration of the unit on the Redundancy Overview screen. The unit must be factory configured as a redundant unit and the function must be set for Redundant operation.
Forced to Yield Control Error	For redundant units only. The unit which was currently in control has yielded control to the other unit because the 2 nd unit has detected that the 1 st was not functioning correctly. Check the fault status and the redundant link wiring of both CPC-II's.

Feedback Faults	This group lists the various diagnostics which monitor the pressure feedback sensor(s). These faults are generally related to performance or calibration of the pressure feedback device(s).
Remote Transducer Low	The analog input value for the remote transducer is below the low diagnostic threshold. Verify that the input is active and connected properly. Note: the function of the 2 nd analog input must be set to Feedback to enable this diagnostic. Verify that the input is active and connected properly. Disable the 2 nd analog input function if it is not used.
Remote Transducer High	The analog input value for the remote transducer is above the high diagnostic threshold. Verify that the input is active and connected properly. Note: the function of the 2 nd analog input must be set to Feedback to enable this diagnostic. Verify that the input is active and connected properly. Disable the 2 nd analog input function if it is not used.
Feedback Spread Above Limit	The difference between the two analog inputs exceeds the spread setting. Note that the AVG mode must be set and spread must be enabled for performance of this diagnostic.
Remote Transducer Scaling Error	The analog input value from the remote transducer is beyond the operating limits. Note: the operating limits are determined by the part number and ratings of the CPC-II. Correct the input range settings,
Internal Pressure Sensor Low	The analog input value from the internal pressure sensor is below the low diagnostic threshold. Verify that the internal sensor is connected properly or replace the internal sensor.
Internal Pressure Sensor High	The analog input value from the internal pressure sensor is above the low diagnostic threshold. Verify that the internal sensor is connected properly or replace the internal sensor.
Temperature Faults	This diagnostic group lists various diagnostics which indicate if the device is operating outside of the recommended thermal operating limits.
Temperature Derating Active	The internal temperature is above the derating threshold. The available drive current to the internal valve will be reduced.
Electronics Temperature Low	The internal temperature is below the rated operating temperature. Increase the temperature by enclosing the unit or providing warm oil to the supply.
Electronics Temperature High	The internal temperature is above the rated operating temperature. Decrease the temperature by cooling the oil supply or reducing the ambient temperature.

Performance Faults

	This diagnostic displays faults related to the ability to control pressure, and the self test function of the return spring. Contact Woodward for further instructions if this diagnostic is active.
Control Pressure Tracking Error	The CPC-II is not able to control the pressure to match the setpoint within the Tracking Fault settings. Ensure that the supply pressure and flow rate are adequate for full transient operation. The Tracking Fault settings can be modified in special cases.
Spring Check Failed	The CPC-II can be configured to perform a self check upon power up. This diagnostic indicates that the spring check has failed. Verify that the oil meets the necessary cleanliness. Inspect the return spring. Note the precautionary warnings on the lower label.

Set-up/Checkout Procedure

1. Verify that the hydraulic and electrical connections are correct, according to Chapter 3.
2. Confirm that the hydraulic and electrical power to the CPC-II is turned off. Remove the top cover of the CPC-II.

**WARNING**

Take care not to damage the threads when removing or replacing the cover.

Damage to sealing surfaces may result in moisture ingress, fire, or explosion. Clean the surface with rubbing alcohol if necessary. Inspect the cover joint surfaces to ensure that they are not damaged or contaminated.

3. Place the cover where the threaded surfaces cannot be damaged or contaminated. Damage to sealing surfaces may result in moisture ingress or explosion hazard.
4. Connect a calibrated pressure gauge to the control pressure line, in order to measure output pressure.
5. Apply electrical power to the CPC-II. The green LED will illuminate and begin flashing when the unit is ready for operation.
6. Check the power supply by measuring the voltage at terminals 1 and 2. Ensure that the voltage is at least 18 volts and not more than 32 volts.
7. Start the hydraulic supply system. Check that the oil is up to operating temperature.
8. Connect a PC to the 9 pin sub-D connector or wire to the appropriate terminations on the main terminal blocks.

9. Operate the unit using the PC service tool or manual adjustment potentiometer.

WARNING

To prevent personal injury or death and damage to equipment, the controlled prime mover must not be allowed to run or operate during this procedure. The main steam valve or main fuel control must be turned off to prevent operation of the controlled system.

10. Purge all air from the system. Adjusting the pressure setpoint up and down several times will aid purging air. Allow for warm-up time.
11. Observe the pressure gauge after changing the setpoint signal. The pressure level should correspond with the setpoint value.

Calibration

This section covers calibration and other electrical adjustments of the CPC-II.

Dynamic Adjustments

1. Ensure that the turbine is shut down, that the steam valves are closed, and the speed of the machine is at zero. Under no conditions should you perform dynamic tuning on an operating steam turbine!

WARNING

To prevent personal injury or death and damage to equipment, the servo must be closed completely when the control pressure is at the minimum level.

Verify that the servo is fully closed when the control pressure is at 4 mA and that the minimum machine speed is not exceeded at this level. Refer to the start up instructions for the prime mover for recommended start-up and verification procedures.

2. Make sure the control is in the shutdown mode (4 mA to 20 mA input to the CPC II is below 2 mA). Verify the following:
 - The servo is at the minimum stop.
 - The control pressure is stable.
 - The gains have switched to the right hand settings labeled "Process PID Settings (At the valve limits or in Slave Mode)" as indicated by the highlighted button.
 - In most cases, the right hand PID settings will not require tuning since they are factory set for stable operation with a blocked servo. However, if instability is observed, lower the proportional gain to 1 and the integral gain to 0.05 to achieve stability. For further optimization, adjust the dynamics as follows:

IMPORTANT

Important Note: If the servo does not reach the fully closed position or if the gains do not switch, reduce the 0 % range setting until the valve is fully closed. The gains should switch to the right-hand group when the servo is on the minimum stop. A good rule is that the 4 mA setting should be 2 % to 5 % below the valve cracking pressure.

3. Step the setpoint from zero to 75 % of the minimum control pressure using the PC service tool manual setpoint. Increase the proportional gain until the feedback pressure moves quickly to the setpoint but with no significant overshoot. Note that when stepping from zero pressure to 75 % of minimum, some delay is expected since the unit is in shutdown prior to the manual setpoint change. If the control pressure overshoots (the setpoint) or oscillates quickly around the setpoint, reduce the proportional gain.
4. Increase the integral gain slightly to reduce the delay time as the unit comes into control. However if overshoot is observed, reduce the integral value. Excessive amount of integral gain can cause the control valve to unseat briefly when the turbine control goes from shutdown to run states.

Note: the Save Values button must be pressed to save these values into non-volatile memory.

5. The derivative setting generally does not require adjustment, however a slight increase in derivative setting can allow the proportional gain to be increased somewhat. If instability is observed, return the derivative value to the default setting of 1 and reduce the proportional gain until proper step response is achieved.
6. Using the manual setpoint, or manual potentiometer, raise the setpoint in small steps until the cracking pressure of the control valve is found. Record this cracking pressure. It should be programmed as the 4 mA setting of the analog input calibration.
7. Raise the control setpoint to within the normal operating range (4 mA to 20 mA). Monitor the stability of the setpoint using the trend plot on the PC service tool or a multi-meter. The signal should be steady within ± 2 % of the control value. If the setpoint signal is not stable, check for proper wiring and shielding or for proper operation of the controller. Note, dither is not required or recommended when using the CPC-II.
8. Using the manual setpoint from the service tool, or the manual potentiometer, adjust the setpoint to 10 % of the servo range. Adjust the left hand PID settings for stable control. **Note:** the Save Values button must be pressed to save these values into non-volatile memory.
9. Step the setpoint by an additional 10 %, or quickly move the manual adjustment potentiometer by a small amount. Increase the proportional gain until the feedback pressure moves quickly to the setpoint. Some overshoot is normal (see Figure 6-12) when in the control range since an increase in pressure is necessary to force flow into the actuator. If the control pressure oscillates quickly around the setpoint, reduce the proportional gain until the controlled pressure is stable.
10. Increase the integral gain to reduce the duration of the overshoot. Larger servo volumes will require a larger integral gain value. Excessive amount of integral gain can cause multiple slow oscillations decreasing until the setpoint is attained, or a slow sustained oscillation around the setpoint. If this low frequency oscillation is observed, reduce the integral gain value.
11. The derivative setting generally does not require adjustment, however a slight increase in derivative setting can allow the proportional gain to be increased somewhat. If instability is observed, return the derivative value to the default setting and reduce the proportional gain until proper step response is achieved.

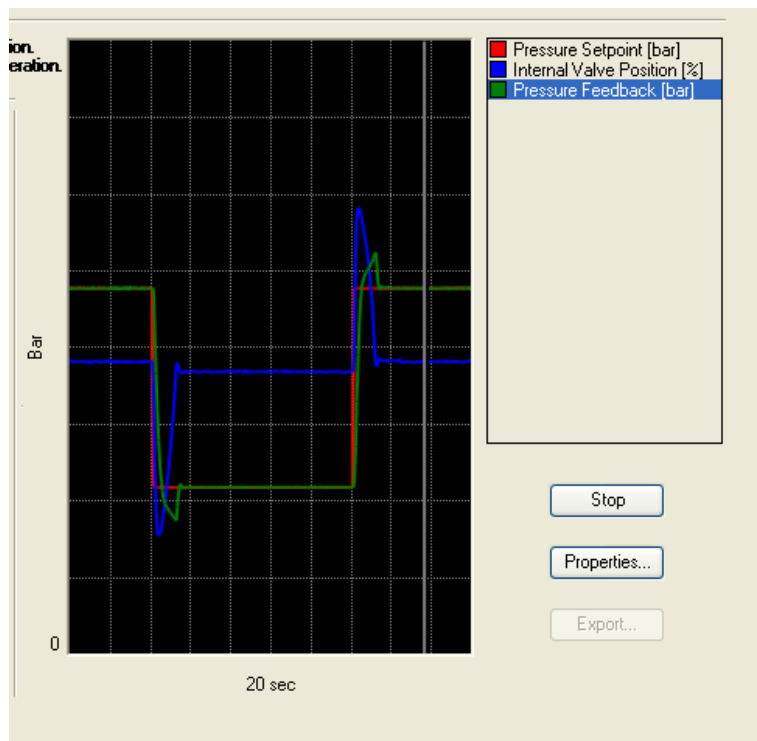

Figure 6-12. Expected Dynamic Performance

Repeat the step response tests at 50 % and 100 %. Ensure that the response is stable at all settings. Confirm that the steady state stability is within ± 2 % of the setpoint value. It should be possible to tune the system to achieve this level of stability.

Analog Output Adjustment

12. The (4 to 20) mA output is calibrated for precise output of current in proportion to the measured pressure. However, it can be field calibrated to match its output to the input calibration of the control system or monitoring device.
13. Adjust the setpoint to the minimum value (actuator minimum travel). Using the settings editor, set the 0 % range mA value to the minimum travel pressure. Verify that the reading is correct at the control system or monitoring device.
14. Adjust the setpoint to the maximum value (actuator maximum travel). Using the settings editor, set the 100 % range mA value to correspond to maximum valve travel pressure. Verify that the reading is correct at the control system or monitoring device.

IMPORTANT

It is important to ensure that the entire control loop including the analog output of the control, the analog input of the CPC-II, the analog output of the CPC-II and the analog input of the control are all properly calibrated so that the read out at the control matches the internal pressure readings.

It is not recommended that closed loop control be attempted at the control as the typical latency and sampling rate is generally not adequate.

Confirm Operation of Discrete Outputs

15. Set the configuration for the discrete outputs to NO or NC behavior as required using the PC service tool. The alarm/shutdown behavior under various diagnostic conditions can also be assigned via the PC service tool. When an error condition is present, such as loss of the setpoint signal, pressure tracking fault, or internal electronics fault, the discrete output will switch state and the red internal LED will flash a code corresponding to the detected conditions. The condition will latch only if configured as a latching fault from the service tool.
16. Invoke a fault condition such as shutting down both setpoint signals. The shutdown should be detected at the main control. Invoke an alarm condition by turning off the hydraulic source. The alarm should be detected at the main control.

IMPORTANT

If an open contact at the CPC-II discrete output will elicit a system shutdown from the main control, additional reliability can be achieved by using both discrete outputs and configuring them to annunciate shutdown faults. In this case the controller must be configured such that both contacts must indicate a fault condition prior to shutdown.

Silt Buster Settings

17. The default silt buster settings are ± 1 % Amplitude, 1 day Pulse Period, and 40 ms Pulse Duration. To set the silt buster correctly, decrease the pulse period to 0.000115 days (10 seconds). Increase the amplitude to a level where a change in pressure is observed, but no change in position can be detected. Normally the default pulse duration of 40 ms should not need to be modified, but if ± 1 % amplitude still causes significant servo movement, the time duration and amplitude can be decreased until the servo position is not effected by the Silt Buster Impulse.
18. Return the pulse period to 1 day. The pulse period can be increased if silt accumulation is particularly heavy. However, extremely dirty oil quality will eventually have adverse effects on the CPC-II and servo system. The system filter should be replaced if the Silt Buster pulse period must be set to very frequent intervals.

Verify Power Supply Capacity and Fault Tracking Settings

19. Verify that the power supply and wiring system are adequate to supply the required transient power for proper dynamic performance.
20. Create a trend of the supply voltage by right clicking on the supply voltage display box at the top of the Detailed Diagnostics Page.
21. Using the manual setpoint from the PC service tool, or the manual potentiometer, perform a step change as large as possible without creating any unsafe or undesirable consequences. Verify that the supply voltage does not dip below 18 Volts during this worst case transient.

22. Verify that the pressure tracking alarm has not triggered. If a pressure tracking fault occurs, improve the PID response by repeating the process listed under Dynamic Adjustments, taking care to set PID parameters for more rapid response. If the nature of the system does not permit adjustment of the PID parameters to achieve a rapid response time, selecting the "Slow" Rate from the PC service tool can reduce the sensitivity of the pressure tracking alarm.

Finish Check-out

23. Disable the manual setpoint or return the manual potentiometer to the full counter clockwise position.
24. Remove additional current and/or voltmeters added during the checkout and verify the wiring is secure and strain relieved in the CPC-II wiring compartment.
25. If applicable, remove the pressure gauge from the control pressure line.
26. Inspect the cover threads to ensure that they have not been damaged or contaminated. If necessary, clean with rubbing alcohol. If the threads are cleaned, reapply a small amount of dry lubricant to the threads.

 **WARNING**

Take care not to damage the threads when removing or replacing the cover.

Damage to sealing surfaces may result in moisture ingress, fire, or explosion. Clean the surface with rubbing alcohol if necessary. Inspect the cover joint surfaces to ensure that they are not damaged or contaminated.

27. Re-install the cover by rotating it clockwise. Tighten to snug by placing a 1 meter bar or wrench between the two cover lugs. Install the locking clamp and torque the locking clamp screw to 4.2 N·m (37 lb-in).
28. The CPC-II is now ready for normal operation.

 **WARNING**

Be prepared to make an emergency shutdown when starting the engine, turbine, or other type of prime mover, to protect against runaway or overspeed with possible personal injury, loss of life, or property damage.

Chapter 7.

Repair and Troubleshooting

General

Repairs and servicing of the CPC-II must be performed by Woodward or its authorized service facilities. No routine maintenance is required with the exception of an external supply filter. If a filter is used, follow the manufacturer's suggested maintenance requirements.

Use of a cable gland or stopping plug that does not meet the hazardous area certification requirements or thread form or thread size will invalidate the suitability for hazardous locations.

Please do not remove or alter the nameplate as it bears important information which may be necessary to service or repair the unit.

Return for Repair Instruction

Should the CPC-II need to be returned for repair, attach a tag on the unit. Include the following information on the tag:

- Customer's name and address
- The name and location where the equipment is installed
- Complete Woodward part number and serial number
- Description of the failure
- Instructions as to what type of repair is to be done

Protective Packaging

The following procedures are used for protective packaging of the CPC-II, if returning for repair:

1. Install shipping plates or plugs in all hydraulic connection ports or seal with tape.
2. Wrap the CPC-II with packaging materials that will not damage the surface of the unit.
3. Place in a double-walled packing carton.
4. Place at least 10 cm of tightly packed, industry-approved, shock-absorbing material around the unit.
5. Secure the carton with strong tape around the outside of the carton to increase the strength of the carton.

Troubleshooting

General

The following troubleshooting guide will help you isolate trouble with the control circuit board, actuator, wiring, and system problems. Troubleshooting beyond this level is recommended ONLY when a complete facility for control testing is available.

The wrong voltage can damage the control. When replacing a control, check the power source and wiring connections for the correct voltage.

Troubleshooting Procedure

This table is a general guide for isolating system problems. In general, most problems are a result of incorrect wiring or installation practices. Make sure that the system wiring, input/output connections, controls and contacts are correct and in good working order. Complete the checks in order. Each check assumes that the preceding checks have been completed and any problems have been corrected. Prior to starting up the CPC-II after troubleshooting, follow the Setup and Check-out Procedure in Chapter 6.



Be prepared to make an emergency shutdown when starting the engine, turbine, or other type of prime mover, to protect against runaway or overspeed with possible personal injury, loss of life, or property damage.

Problem	Cause	Remedy
No pressure at the control port	Faulty power, check for green LED.	Check power connections, 24 V (dc) at J2 pins 11(+) and 12(-).
	Error condition, check red LED (alarm or shutdown; discrete output is active).	If on: Check actuator wire connection.
	No hydraulic supply.	Check hydraulic supply pressure and ensure all lines are connected to the appropriate ports.
	Power supply too weak.	Change power supply. See specification.
	Power supply is limiting current.	Change limit level to maximum (≥ 5 A).
	Bad power supply.	Use Woodward recommended power supply.
	Electronics fault in CPC-II.	Check for electronics fault using PC service tool.
Full pressure out	Fluid lines incorrectly installed.	Check fluid connections.
	Contamination within control.	Check the fluid for excessive contamination. Replace or add a system filter ahead of the CPC-II supply. Increase the frequency of the Silt Buster impulse. Contact Woodward service.
Slow dynamics	Dynamic adjustments not optimal.	Raise proportional and integral gain settings.
	Cold oil (viscosity too high).	Wait until normal temperature is reached or change dynamic adjustments (raise proportional or integral gain).
	Tubes too small or too long.	Use bigger and/or shorter tubes.
	Pressure Tracking Alarm.	Optimize PID settings. Reduce pressure tracking fault rate.

Problem	Cause	Remedy
High-frequency oscillation	Control settings are attempting to regulate the Servo outside its travel range (excessive hydraulic stiffness).	Modify input scaling and/or gain switching values. Reduce the At Valve Limit PID settings if attempting to control the unit below the opening travel.
	Dynamic adjustments are not optimal	Lower proportional gain setting.
	High friction in servo.	Clean or change servo piston.
	High CPC-II internal friction.	Check the fluid for excessive contamination. Replace or add a system filter ahead of the CPC-II supply. Increase the frequency of the Silt Buster impulse. Contact Woodward service.
Low-frequency oscillation	Dynamic adjustments are not optimal.	Lower integral gain.
Discrete outputs not working	Incorrect wiring.	Correct wiring.
(4 to 20) mA output not working	Incorrect wiring.	Correct wiring. Verify analog output settings match control.
Intermittent behavior	Intermittent wiring.	Replace faulty wire(s).
	Damaged insulation.	Replace faulty wire(s).
	Bad contact at connectors.	Re-install all wires.
	Too high ambient or oil temperature.	Lower temperature. See specification.
Leaking inside CPC-II	Pressure sensor is loose, O-ring is damaged.	Retorque the pressure sensor. Replace O-ring.
	Excessive input control noise.	Reduce or eliminate dither at turbine control. Check wiring for ground loops. Check for instability, reduce dynamic settings at CPC-II or main control.
Large servo-position hysteresis	Abnormal high friction in servo.	Clean or change servo piston.
Non-zero pressure when shut down	Drain pressure is too high.	Reduce Drain pressure.
Slave unit (redundant units) takes control but no faults are shown on Master	Redundant Link Failure between Master and Slave units.	Check Wiring between units. Check for valid pulse train on Discrete Output 3 of Master Unit.
Force to Yield Control Error on Master	Redundant Link Failure between Master and Slave units.	

Chapter 8. Replacing Older CPCs and Non-Woodward Converters with the New CPC-II

The new CPC-II is interchangeable and can replace older CPC models. Please refer to the following Chart:

Old CPC Part Number	Area Classification	Control Pressure Range	CPC-II Part Number
8901-455 8901-457 8901-459	Class I, Division 2, ATEX Zone 2	0–10 bar	9907-1106
		0–25 bar	9907-1102
9907-046 9907-477 9907-802 9907-803	Class I, Division 1 Class I, Division 2 ATEX Zone 1 and Zone 2	0–10 bar	9907-1103
		0–25 bar	9907-1100

Woodward adapter kit 8928-7240 is available to replace Voith Model E360 I/H converters with the CPC-II. Contact your local Woodward sales office or distributor for additional information.

Chapter 9. Service Options

Product Service Options

If you are experiencing problems with the installation, or unsatisfactory performance of a Woodward product, the following options are available:

- Consult the troubleshooting guide in the manual.
- Contact the manufacturer or packager of your system.
- Contact the Woodward Full Service Distributor serving your area.
- Contact Woodward technical assistance (see “How to Contact Woodward” later in this chapter) and discuss your problem. In many cases, your problem can be resolved over the phone. If not, you can select which course of action to pursue based on the available services listed in this chapter.

OEM and Packager Support: Many Woodward controls and control devices are installed into the equipment system and programmed by an Original Equipment Manufacturer (OEM) or Equipment Packager at their factory. In some cases, the programming is password-protected by the OEM or packager, and they are the best source for product service and support. Warranty service for Woodward products shipped with an equipment system should also be handled through the OEM or Packager. Please review your equipment system documentation for details.

Woodward Business Partner Support: Woodward works with and supports a global network of independent business partners whose mission is to serve the users of Woodward controls, as described here:

- A **Full Service Distributor** has the primary responsibility for sales, service, system integration solutions, technical desk support, and aftermarket marketing of standard Woodward products within a specific geographic area and market segment.
- An **Authorized Independent Service Facility (AISF)** provides authorized service that includes repairs, repair parts, and warranty service on Woodward's behalf. Service (not new unit sales) is an AISF's primary mission.
- A **Recognized Engine Retrofitter (RER)** is an independent company that does retrofits and upgrades on reciprocating gas engines and dual-fuel conversions, and can provide the full line of Woodward systems and components for the retrofits and overhauls, emission compliance upgrades, long term service contracts, emergency repairs, etc.
- A **Recognized Turbine Retrofitter (RTR)** is an independent company that does both steam and gas turbine control retrofits and upgrades globally, and can provide the full line of Woodward systems and components for the retrofits and overhauls, long term service contracts, emergency repairs, etc.

A current list of Woodward Business Partners is available at www.woodward.com/support/directory.cfm.

Woodward Factory Servicing Options

The following factory options for servicing Woodward products are available through your local Full-Service Distributor or the OEM or Packager of the equipment system, based on the standard Woodward Product and Service Warranty (5-01-1205) that is in effect at the time the product is originally shipped from Woodward or a service is performed:

- Replacement/Exchange (24-hour service)
- Flat Rate Repair
- Flat Rate Remanufacture

Replacement/Exchange: Replacement/Exchange is a premium program designed for the user who is in need of immediate service. It allows you to request and receive a like-new replacement unit in minimum time (usually within 24 hours of the request), providing a suitable unit is available at the time of the request, thereby minimizing costly downtime. This is a flat-rate program and includes the full standard Woodward product warranty (Woodward Product and Service Warranty 5-01-1205).

This option allows you to call your Full-Service Distributor in the event of an unexpected outage, or in advance of a scheduled outage, to request a replacement control unit. If the unit is available at the time of the call, it can usually be shipped out within 24 hours. You replace your field control unit with the like-new replacement and return the field unit to the Full-Service Distributor.

Charges for the Replacement/Exchange service are based on a flat rate plus shipping expenses. You are invoiced the flat rate replacement/exchange charge plus a core charge at the time the replacement unit is shipped. If the core (field unit) is returned within 60 days, a credit for the core charge will be issued.

Flat Rate Repair: Flat Rate Repair is available for the majority of standard products in the field. This program offers you repair service for your products with the advantage of knowing in advance what the cost will be. All repair work carries the standard Woodward service warranty (Woodward Product and Service Warranty 5-01-1205) on replaced parts and labor.

Flat Rate Remanufacture: Flat Rate Remanufacture is very similar to the Flat Rate Repair option with the exception that the unit will be returned to you in “like-new” condition and carry with it the full standard Woodward product warranty (Woodward Product and Service Warranty 5-01-1205). This option is applicable to mechanical products only.

Returning Equipment for Repair

If a control (or any part of an electronic control) is to be returned for repair, please contact your Full-Service Distributor in advance to obtain Return Authorization and shipping instructions.

When shipping the item(s), attach a tag with the following information:

- return authorization number;
- name and location where the control is installed;
- name and phone number of contact person;
- complete Woodward part number(s) and serial number(s);
- description of the problem;
- instructions describing the desired type of repair.

Packing a Control

Use the following materials when returning a complete control:

- protective caps on any connectors;
- antistatic protective bags on all electronic modules;
- packing materials that will not damage the surface of the unit;
- at least 100 mm (4 inches) of tightly packed, industry-approved packing material;
- a packing carton with double walls;
- a strong tape around the outside of the carton for increased strength.

NOTICE

To prevent damage to electronic components caused by improper handling, read and observe the precautions in Woodward manual 82715, *Guide for Handling and Protection of Electronic Controls, Printed Circuit Boards, and Modules*.

Replacement Parts

When ordering replacement parts for controls, include the following information:

- the part number(s) (XXXX-XXXX) that is on the enclosure nameplate;
- the unit serial number, which is also on the nameplate.

Engineering Services

Woodward offers various Engineering Services for our products. For these services, you can contact us by telephone, by email, or through the Woodward website.

- Technical Support
- Product Training
- Field Service

Technical Support is available from your equipment system supplier, your local Full-Service Distributor, or from many of Woodward's worldwide locations, depending upon the product and application. This service can assist you with technical questions or problem solving during the normal business hours of the Woodward location you contact. Emergency assistance is also available during non-business hours by phoning Woodward and stating the urgency of your problem.

Product Training is available as standard classes at many of our worldwide locations. We also offer customized classes, which can be tailored to your needs and can be held at one of our locations or at your site. This training, conducted by experienced personnel, will assure that you will be able to maintain system reliability and availability.

Field Service engineering on-site support is available, depending on the product and location, from many of our worldwide locations or from one of our Full-Service Distributors. The field engineers are experienced both on Woodward products as well as on much of the non-Woodward equipment with which our products interface.

For information on these services, please contact us via telephone, email us, or use our website: www.woodward.com/support.

How to Contact Woodward

For assistance, call one of the following Woodward facilities to obtain the address and phone number of the facility nearest your location where you will be able to get information and service.

Electrical Power Systems

Facility	Phone Number
Brazil	+55 (19) 3708 4800
China	+86 (512) 6762 6727
Germany:	
Kempen	+49 (0) 21 52 14 51
Stuttgart	+49 (711) 78954-0
India	+91 (129) 4097100
Japan	+81 (43) 213-2191
Korea	+82 (51) 636-7080
Poland	+48 12 295 13 00
United States	+1 (970) 482-5811

Engine Systems

Facility	Phone Number
Brazil	+55 (19) 3708 4800
China	+86 (512) 6762 6727
Germany:	
Stuttgart	+49 (711) 78954-0
India	+91 (129) 4097100
Japan	+81 (43) 213-2191
Korea	+82 (51) 636-7080
The Netherlands	+31 (23) 5661111
United States	+1 (970) 482-5811

Turbine Systems

Facility	Phone Number
Brazil	+55 (19) 3708 4800
China	+86 (512) 6762 6727
India	+91 (129) 4097100
Japan	+81 (43) 213-2191
Korea	+82 (51) 636-7080
The Netherlands	+31 (23) 5661111
Poland	+48 12 295 13 00
United States	+1 (970) 482-5811

You can also contact the Woodward Customer Service Department or consult our worldwide directory (www.woodward.com/support/directory.cfm) for the name of your nearest Woodward distributor or service facility.

Technical Assistance

If you need to telephone for technical assistance, you will need to provide the following information. Please write it down here before phoning:

Your Name _____

Site Location _____

Phone Number _____

Fax Number _____

Engine/Turbine Model Number _____

Manufacturer _____

Number of Cylinders (if applicable) _____

Type of Fuel (gas, gaseous, steam, etc) _____

Rating _____

Application _____

Control/Governor #1

Woodward Part Number & Rev. Letter _____

Control Description or Governor Type _____

Serial Number _____

Control/Governor #2

Woodward Part Number & Rev. Letter _____

Control Description or Governor Type _____

Serial Number _____

Control/Governor #3

Woodward Part Number & Rev. Letter _____

Control Description or Governor Type _____

Serial Number _____

If you have an electronic or programmable control, please have the adjustment setting positions or the menu settings written down and with you at the time of the call.

Chapter 10.

Asset Management and Refurbishment Scheduling Period

This product is designed for continuous operation in a typical industrial environment and includes no components that require periodic service. However, to take advantage of related product software and hardware improvements, we recommend that your product be sent back to Woodward or to a Woodward authorized service facility after every five to ten years of continuous service for inspection and component upgrades. Please refer to the above service programs when returning products.

Chapter 11.

Long-Term Storage Requirements

Units that will not be put into service within twelve months should be packaged for long-term storage as described in Woodward manual 25075.



DECLARATION OF CONFORMITY

Manufacturer's Name: WOODWARD GOVERNOR COMPANY (WGC)
Industrial Controls Group

Manufacturer's Address: 1000 E. Drake Rd.
Fort Collins, CO, USA, 80525

Model Name(s)/Number(s): CPC-II 9907-1100 and 9907-1103

Conformance to Directive(s): 2004/108/EC COUNCIL DIRECTIVE of 15 December 2004 on the approximation of the laws of the Member States relating to electromagnetic compatibility and all applicable amendments.
94/9/EC COUNCIL DIRECTIVE of 23 March 1994 on the approximation of the laws of the Member States concerning equipment and protective systems intended for use in potentially explosive atmospheres

Marking(s):  Category 2 Group II G, Ex d IIB T3 or
 Category 3 Group II G, Ex nA IIC T3

Applicable Standards: EN61000-6-2, (2005): EMC Part 6-2: Generic Standards - Immunity for Industrial Environments
EN61000-6-4, (2007): EMC Part 6-4: Generic Standards - Emissions for Industrial Environments
EN60079-0, 2004 Electrical Apparatus for Explosive Gas Atmospheres - Part 0: General Requirements
EN60079-1, 2004 Equipment Protected by Flameproof Enclosures "d"
EN60079-15, 2005: Electrical apparatus for explosive gas atmospheres - Part 15: Construction, test and marking of type of protection 'n' electrical apparatus

Third Party Certification Information: LCIE 08 ATEX 6123
LCIE 08 ATEX 6124
LCIE - Siège Social : 33, Avenue du Général Leclerc
F92260 Fontenay-aux-Roses, France

Conformity Assessment: ATEX Production Quality Assessment, ITS05ATEXQ4211

Notified Body For ATEX: Intertek (0359)
Intertek House, Cleeve Road
Leatherhead, Surrey, KT22 7SB UK

We, the undersigned, hereby declare that the equipment specified above conforms to the above Directive(s).

MANUFACTURER



Signature

Joseph Driscoll

Full Name

Engineering Manager

Position

WGC, Fort Collins, CO, USA

Place

12/16/08

Date

DECLARATION OF CONFORMITY

Manufacturer's Name: WOODWARD GOVERNOR COMPANY (WGC)
Industrial Controls Group

Manufacturer's Address: 1000 E. Drake Rd.
Fort Collins, CO, USA, 80525

Model Name(s)/Number(s): CPC-II, / 9907-1102, 9907-1105, and 9907-1106

Conformance to Directive(s): 2004/108/EC COUNCIL DIRECTIVE of 15 December 2004 on the approximation of the laws of the Member States relating to electromagnetic compatibility and all applicable amendments.

94/9/EC COUNCIL DIRECTIVE of 23 March 1994 on the approximation of the laws of the Member States concerning equipment and protective systems intended for use in potentially explosive atmospheres

Marking(s):  Category 3 Group II G, Ex nA IIC T3

Applicable Standards: EN61000-6-2, (2005): EMC Part 6-2: Generic Standards - Immunity for Industrial Environments

EN61000-6-4, (2007): EMC Part 6-4: Generic Standards - Emissions for Industrial Environments

EN60079-0, 2004 Electrical Apparatus for Explosive Gas Atmospheres - Part 0: General Requirements

EN60079-15, 2005: Electrical apparatus for explosive gas atmospheres - Part 15: Type of protection 'n'

We, the undersigned, hereby declare that the equipment specified above conforms to the above Directive(s).

MANUFACTURER

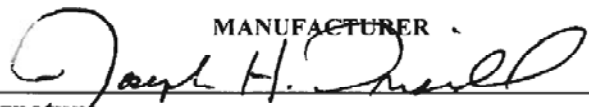

Signature

Joseph Driscoll

Full Name

Engineering Manager

Position

WGC, Fort Collins, CO, USA

Place

12/15/08

Date

DECLARATION OF CONFORMITY

Manufacturer's Name: WOODWARD GOVERNOR COMPANY (WGC)
Manufacturer's Address: 1000 E. Drake Rd.
Fort Collins, CO, USA, 80525
Model Name(s)/Number(s): CPC-II, / 9907-1191
Conformance to Directive(s): 2004/108/EC COUNCIL DIRECTIVE of 15 December 2004 on the approximation of the laws of the Member States relating to electromagnetic compatibility and all applicable amendments.

94/9/EC COUNCIL DIRECTIVE of 23 March 1994 on the approximation of the laws of the Member States concerning equipment and protective systems intended for use in potentially explosive atmospheres

Marking(s):  Category 3 Group II G, Ex nA IIC T4
Applicable Standards: EN61000-6-2, (2005): EMC Part 6-2: Generic Standards - Immunity for Industrial Environments

EN61000-6-4, (2007): EMC Part 6-4: Generic Standards - Emissions for Industrial Environments

EN60079-0, 2004 Electrical Apparatus for Explosive Gas Atmospheres - Part 0: General Requirements

EN60079-15, 2005: Electrical apparatus for explosive gas atmospheres - Part 15: Type of protection 'n'

We, the undersigned, hereby declare that the equipment specified above conforms to the above Directive(s).

MANUFACTURER

Signature

Suhail Horan

Full Name

Quality Manager

Position

WGC, Fort Collins, CO, USA

Place

12-Aug-2010

Date

Declaration of Incorporation

Woodward Governor Company
1000 E. Drake Road
Fort Collins, Colorado 80525
United States of America

Product: CPC-II
Part Number: 9907-1100, 9907-1102, 9907-1103, 9907-1105, and
9907-1106

The undersigned hereby declares, on behalf of Woodward Governor Company of Loveland and Fort Collins, Colorado, that the above-referenced product is in conformity with the following EU Directives as they apply to a component:

98/37/EC (Machinery)

This product is intended to be put into service only upon incorporation into an apparatus/system that itself will meet the requirements of the above Directives and bears the CE mark.

MANUFACTURER

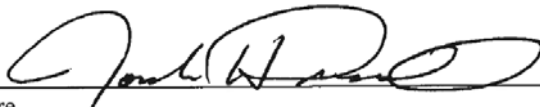

Signature

Joseph Driscoll
Full Name

Engineering Manager
Position

WGC, Fort Collins, CO, USA
Place

12/15/08
Date

СИСТЕМА СЕРТИФИКАЦИИ ГОСТ Р
ГОССТАНДАРТ РОССИИ



СЕРТИФИКАТ СООТВЕТСТВИЯ

№ РОСС US.ГБ04.В01140

Срок действия с 22.12.2008 г. по 22.12.2011 г.

8542716

ОРГАН ПО СЕРТИФИКАЦИИ

Per. № РОСС RU.0001.11ГБ04 ЦЕНТР СЕРТИФИКАЦИИ «СТВ»
607190, г. Саров Нижегородской обл., пр. Мира, 37
телефон (83130) 454-78, факс (83130) 455-30

ПРОДУКЦИЯ

Преобразователь тока в давление типа CPC - II
с маркировкой взрывозащиты 2ExnAIIТЗХ, 1ExdIIВТЗХ;

серийный выпуск

код ОК 005 (ОКП):

42 1831

СООТВЕТСТВУЕТ ТРЕБОВАНИЯМ НОРМАТИВНЫХ ДОКУМЕНТОВ

ГОСТ Р 51330.0-99
ГОСТ Р 51330.1-99
ГОСТ Р 51330.14-99

код ТН ВЭД России:

9032 89 000 9

ИЗГОТОВИТЕЛЬ

Woodward Governor Co.
1000 East Drake Road, Fort Collins CO 80525, USA

СЕРТИФИКАТ ВЫДАН

Woodward Governor Co.
1000 East Drake Road, Fort Collins CO 80525, USA
Тел.: +1 (970) 482 5811, Факс: +1 (970) 498 3058

НА ОСНОВАНИИ

- протокола оценки и испытаний № СЗ-853/08 от 16.12.2008 г. Центра сертификации "СТВ" (Per.№ РОСС RU.0001.11ГБ04);
- акта о результатах анализа состояния производства от 21.11.2008 г. Центра сертификации "СТВ" (Per.№ РОСС RU.0001.11ГБ04)

ДОПОЛНИТЕЛЬНАЯ ИНФОРМАЦИЯ

Специальные условия безопасного применения - в соответствии с Дополнением к сертификату.
Схема сертификации За



Руководитель органа

подпись

В.В. Байрак

инициалы, фамилия

Эксперт

подпись

А.К. Давыденков

инициалы, фамилия

Сертификат имеет юридическую силу на всей территории Российской Федерации

We appreciate your comments about the content of our publications.

Send comments to: icinfo@woodward.com

Please reference publication **26448G**.



B26448:G



PO Box 1519, Fort Collins CO 80522-1519, USA
1000 East Drake Road, Fort Collins CO 80525, USA
Phone +1 (970) 482-5811 • Fax +1 (970) 498-3058

Email and Website—www.woodward.com

Woodward has company-owned plants, subsidiaries, and branches,
as well as authorized distributors and other authorized service and sales facilities throughout the world.

Complete address / phone / fax / email information for all locations is available on our website.